

AB-2 INDUSTRIAL AIR CURTAIN RANGE AMBIENT, ELECTRIC & LPHW MODELS



INSTALLATION & SERVICE MANUAL



These appliances meet the following EC directives:
The Eco design for Energy-Related Products and Energy Information (Amendment) (EU Exit)
Regulations 2020
Electromagnetic Compatibility Regulations 2016
Electrical Equipment (Safety) Regulations 2016
Supply of Machinery (Safety) Regulations 2008
Supply of Machinery (Safety) Regulations (A) 2011

Please read this document carefully before commencing installation, commissioning and/or servicing.
Leave it with the end user/site agent to be placed in their premises technical file after installation.

WARNING

Improper installation, adjustment, alteration, service or maintenance can cause property damage, injury or death.
All work must be carried out by appropriately qualified persons.
The manufacturer does not take any responsibility in the event of non-observance of the regulations concerning the connection of the apparatus causing a dangerous operation possibly resulting in damage to the apparatus and/or environment in which the unit is installed.

Document Index

GENERAL INFORMATION	3
SECTION 1 – TECHNICAL INFORMATION	4
SECTION 2 – DIMENSIONS	4
2.1 Weights	4
SECTION 3 – INSTALLATION DETAILS	4
3.1 Health and safety	4
3.2 Single module	5
3.3 Multiple modules	5
3.4 Mounting	5
3.5 LPHW models only	6
SECTION 4 – WIRING DETAILS	7
4.1 Control panel	7
SECTION 5 – SERVICING	7
5.1 Tools required	7
5.2 Air outlet louvres	7
5.3 Air distribution fans	7
5.4 Elements	7
5.5 Electrical	7
SECTION 6 – PARTS REPLACEMENT	7
6.1 Tools required	7
6.2 Air distribution fans	7
6.2.1 Fan closure plate	8
6.2.2 Fan removal	8
6.3 Heating element removal	9
SECTION 7 – SPARE PARTS	10
SECTION 8 – FAULT FINDING	10
SECTION 9 – USER INSTRUCTIONS	11
9.1 Important information	11
9.2 Control panel	11
9.3 To start the AB air curtain	11
Sample wiring diagrams	12

General Information

Welcome to the AB-2 air curtain range. There are 3 variants within the range, Ambient (unheated), Electric heated & LPHW. With two sizes - 175 & 225.

Local regulations may vary in the country of use and it is the installers responsibility to ensure that such regulations are satisfied.

All installation, assembly, commissioning and service procedures must be carried out by suitably qualified competent persons to the statutory regulations in the country of use.

When assembling, installing, commissioning and servicing is undertaken on the air curtains please ensure that working at height regulations are adhered to at the mounting heights specified. All dimensions shown are in mm unless otherwise stated.

The manufacturer reserves the right to alter specifications without prior notice.



PLEASE READ this document prior to installation to familiarise yourself with the components and tools you require at the various stages.

This manual provides detailed information on the installation of AB-2 air curtains. It is essential that these products are installed in accordance with these manufacturers instructions.



UNDER NO CIRCUMSTANCES MAKE MODIFICATIONS TO THE MACHINE AND IT'S INTENDED USE.

The manufacturer declines all responsibility for any damages which may be, directly or indirectly, caused to exposed persons or property, due to improper use or use of the machine for different purposes other than the design purposes, incorrect installation, inappropriate power supply, different or changes to the installation environment from the one declared during order confirmation, grave deficiency of maintenance, unauthorized alterations and modifications, use of non-original spare parts, removal of the protection guards, ignoring the instructions for use, negligence, etc.

The primary reason for installing an air curtain is to prevent the influx of cold outside air through a door opening into a heated area. Typical applications include large despatch bay doors in factories and warehouses, and internal doors between areas of different temperatures. Wider door openings can be accommodated by bolting two or more units together. Air curtains control the internal climate by emitting an air stream with enough velocity to meet the floor so creating an air barrier in the door area. To prevent the

ingress of outside draughts, the discharge louvre is angled outwards, so that the air leaving the building meets the wind trying to enter, thus deflecting it. (See diagrams below).

AB air curtains provide uniform air distribution across the full width of the door, keeping heated or conditioned air inside the building and stopping the ingress of cold air, draughts and dust.



Without an air curtain

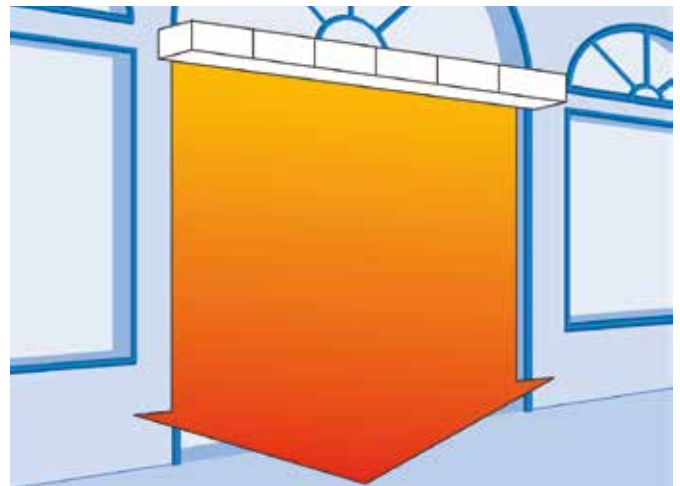

With an air curtain

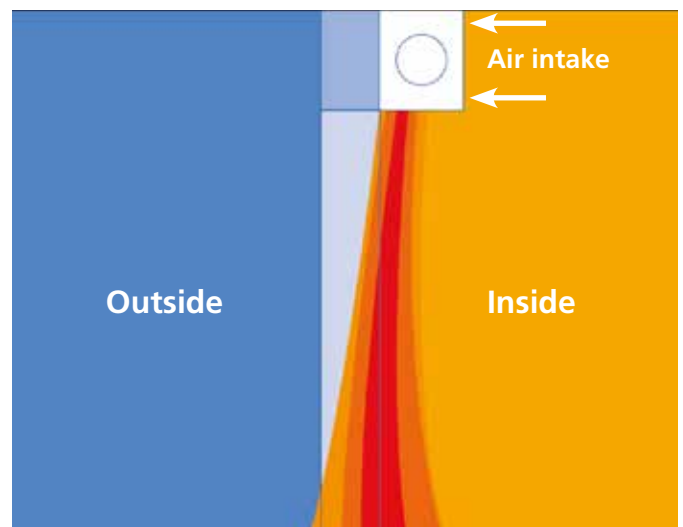

Pattern of airflow

1. Technical information

Model	AB175-2	AB225-2
Air distribution fans		
Type	Centrifugal c/w thermal trip	
Speeds	3	3
No of fans	3	4
Max air volume (ambient only)	9,600m ³ /h	12,800m ³ /h
Electrical supply ambient & LPHW models*	230V 1 Phase 50Hz	
Current per fan (FLC)	5.2 A	5.2 A
Starting current per fan	12 A	12 A
*When multiple modules are used for a single door, a 3 phase supply is required		
Electric Heated models only		
Elements	18 kW	24 kW
Electrical supply	415V 3 Phase 50Hz	
Total power consumption	21.42 kW	30.56 kW
Max air volume	9,600m ³ /h	12,800m ³ /h
Temp rise - High speed	9.7°C	7.28°C
Temp rise - Low speed	13.86°C	10.39°C
LPHW models only		
Coil rating	53 kW	63 kW
Water pressure drop thru coil	12 kpa	15 kpa
Water flow	1.18 l/s	1.4 l/s
Water capacity	3.5 Litres	4.5 Litres
Max water operating pressure	15 bar	15 bar
Max air volume	7,560m ³ /h	9,400m ³ /h
Temp rise - High speed*	20°C	20°C
Temp rise - Low speed*	29°C	29°C
*Based upon LPHW flow temp of 82°C, return 71°C		



WARNING: This air curtain should not be installed within a corrosive atmosphere.

2. Dimensions (mm)

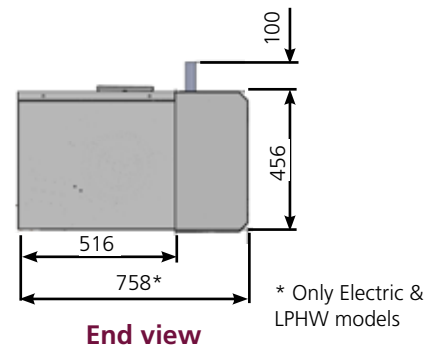

End view

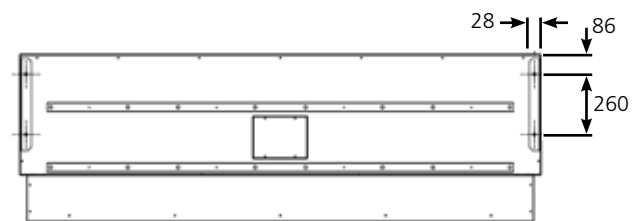

Plan view

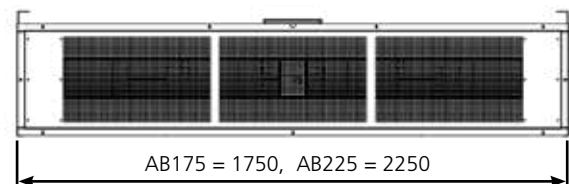

Front view

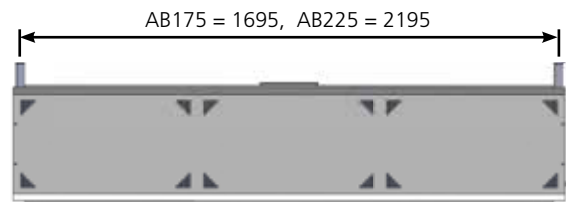

LPHW Coil Centres

2.1 Weights

Model	Ambient	Electric	LPHW	
			Dry	Wet
175	92kg	105kg	134kg	139kg
225	114kg	130kg	162kg	167kg

All weights are approximate

3. Installation details.

3.1 Health and Safety.

Due account should be taken of any obligations arising from the national Health and Safety legislation or relevant codes of practice. In addition the installation must be carried out in accordance with the current IEE wiring regulations and any other relevant national Standards and Codes of Practice by a qualified installer. Isolate all electrical supplies to the heater & control panel before proceeding.

For your own safety we recommend the use of personal protective equipment when handling this air curtain. AB air curtains are supplied with mounting brackets pre-fitted, and can be mounted either as single units, or in multiples, which can be bolted together to suit various door widths.

The minimum mounting height is 3m (See diagram 2).

3.2 Single module

Each single air curtain should be supported by cantilever brackets (not supplied) then fixed back to the building structure by bolting directly using suitable support brackets, or by suspending from above using suitable steelwork. (See diagram 3, page 6).

3.3 Multiple modules

Multiple air curtains should be bolted together using 3 off M10 set pins, nuts and washers fitted through the holes provided in the mounting brackets, then suitable support channels (not supplied) must be fixed on top of the factory fitted brackets along the full length of the assembled air curtains to spread the load.

The assembly can now be fixed back to the building structure by bolting directly using suitable support brackets, or suspending from above using steelwork. (See diagram 4 page 6).

If required, the support channel may be extended slightly past the ends of the air curtains to aid fixing.



Note: Where multiple air curtains are fitted above up and over doors or where central support is inappropriate, the support channel should be replaced with channels of a greater cross section to prevent the assembly from bending.

It may be necessary to adjust the position of the air outlet louvres to provide the correct airflow across the door opening. This can be done by first loosening the four locking pins located two at each end of the louvres (arrowed, Fig. A), then loosening the intermediate locking Allen pins (arrowed, Fig. B). The louvres can now be moved to the desired position and the locking pins re-tightened.



Note: The AB 225 model has two pairs of intermediate locking Allen pins, whereas the AB 175 model only has one pair.

3.4 Mounting

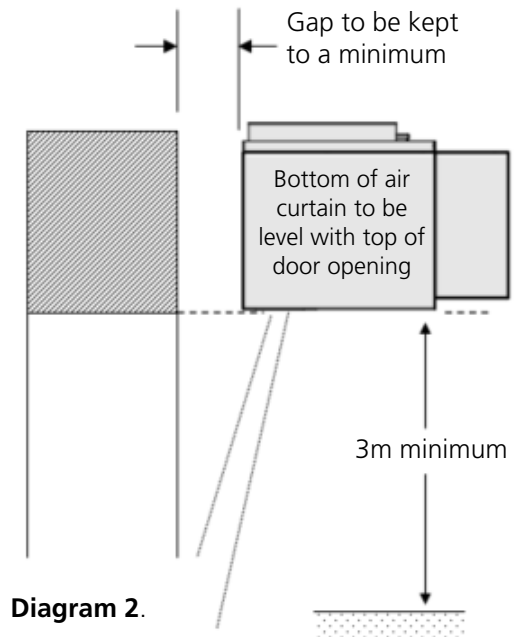

Diagram 2.

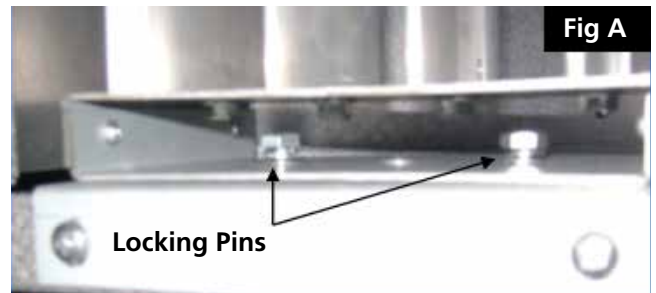

Fig A



Fig B

Diagram 3. Mounting method (single module)

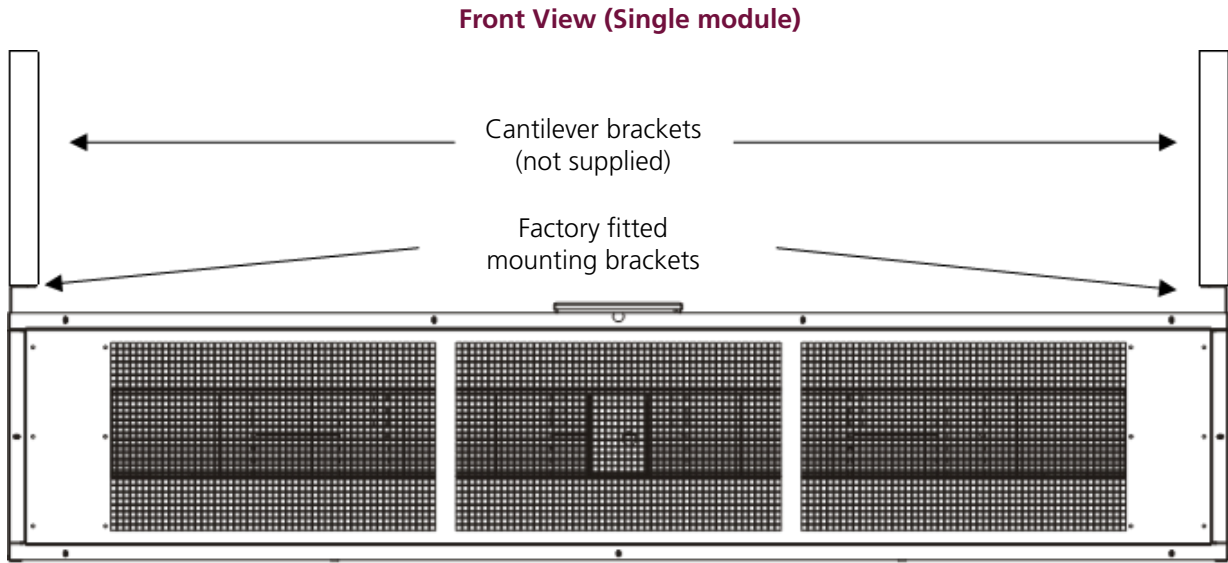
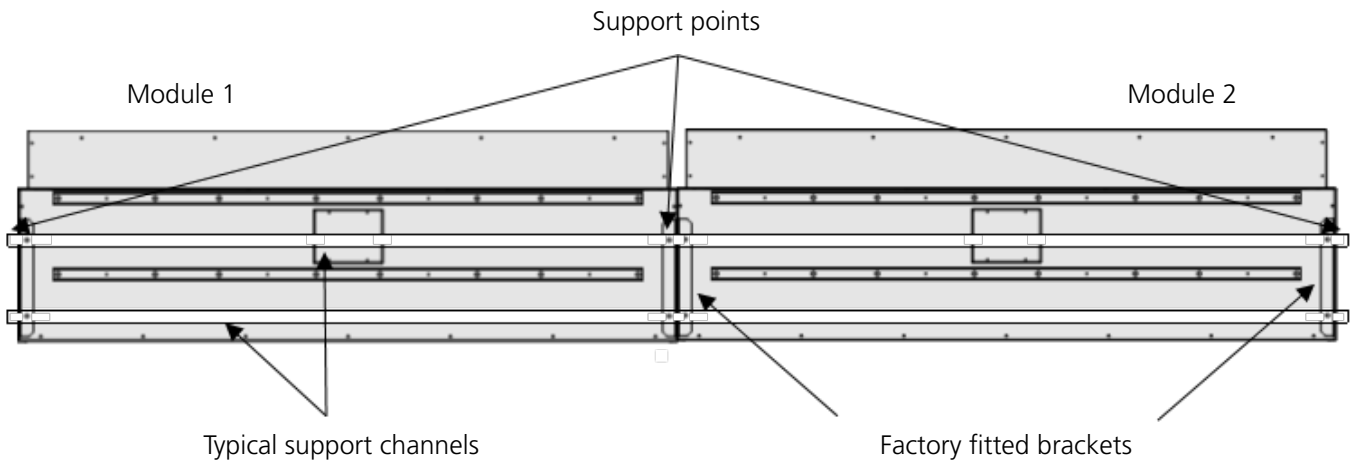

Diagram 4. Support channel (multiple modules)

Plan View (Twin modules)



WARNING: This air curtain should not be installed within a corrosive atmosphere.

3.5 LPHW models only.

Each AB module is fitted with a 1¼" (BSP) flow and return connection. When more than one module is used, size of the common pipework is to be calculated by the installer using the flow information shown within technical data on page 4.

Use of an isolation valve in the pipework for each coil connection, is highly recommended.

The image on the right illustrates a typical installation using two AB-2 modules.

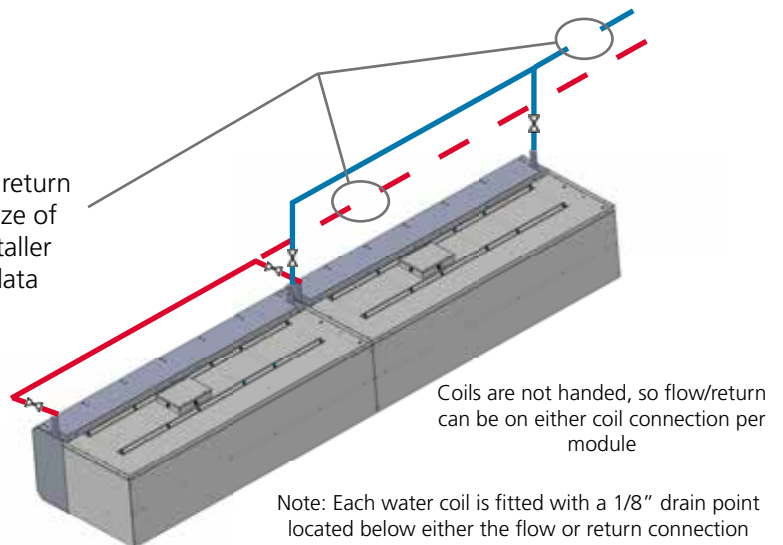

4. Wiring details

4.1 Control panel

The panel incorporates an on/off selector switch, a high/low fan speed selector switch, and a heat on/off selector switch.

Panel operation is described in section 9 of this manual (user instructions).



A customer specific control panel wiring diagram will be supplied within each air curtain control panel. However sample diagrams are shown at the rear of this manual

5. Servicing

These appliances should be serviced annually by a competent person to ensure safe and efficient operation. In exceptionally dusty or polluted conditions more frequent servicing may be required.

Isolate electricity supplies before commencing any work.

5.1 Tools required

The following tools and equipment are recommended to complete the tasks laid out in this manual.



Allen key set



10mm & 13mm Spanners



Small flat head screwdriver



Soft brush



Adjustable spanner



Cross point screwdriver

5.2 Air outlet louvres.

The air outlet louvres should be cleaned with a soft brush. Check that the louvres are set to the required angle. (See Figs. A/B on page 5 for setting procedure).

5.3 Air distribution fans.

The air distribution fans can be accessed by opening the fan access lid as described in section 7.1 Fig.2.

Clean off any dust or deposits with a soft brush paying particular attention to the impeller. Check that the impeller spins freely, and that there is no play in the fan bearings.

The fan(s) can be removed, if necessary, as described in section 6.2.

5.4 Elements

Remove element housing as described in section 6.3 (parts replacement). Clean off any dust or deposits with a soft brush.

Visually inspect element coils for signs of discolouration, burning, sagging etc.

5.5 Electrical.



Isolate electricity supplies before commencing any work.

Check condition and tightness of all terminations in control panel.

Remove the fan/elements terminal box cover located on top of the air curtain (Fig.1), and repeat above procedure for the fan/elements terminations.

Check that the plug/socket connection to each fan (inside the unit) is tight and that the cable is in good condition. Switch control panel on and check air curtain operation in each selector switch position (heat on/off, low//high speed).



Fig 1

6. Parts replacement



All servicing/maintenance work on this air curtain should be carried out by suitably qualified person. Before commencing any work please ensure that the electricity supplies are turned off.

6.1 Tools required.



Allen key set



10mm & 13mm Spanners



Adjustable spanner



Cross point screwdriver

6.2 Air distribution fans.

The air distribution fans can be accessed by removing the three screws along the bottom edge of the air inlet grille (Fig.2), and the retaining screws securing the hinged lid on the underside of the air curtain next to the louvres (Fig.3).

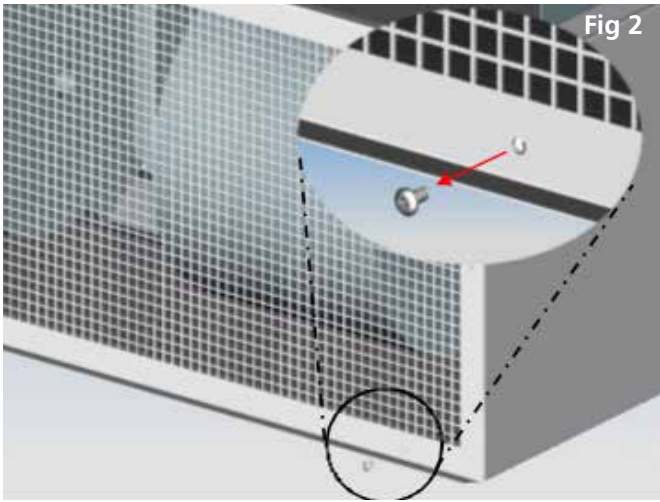

Fig 2

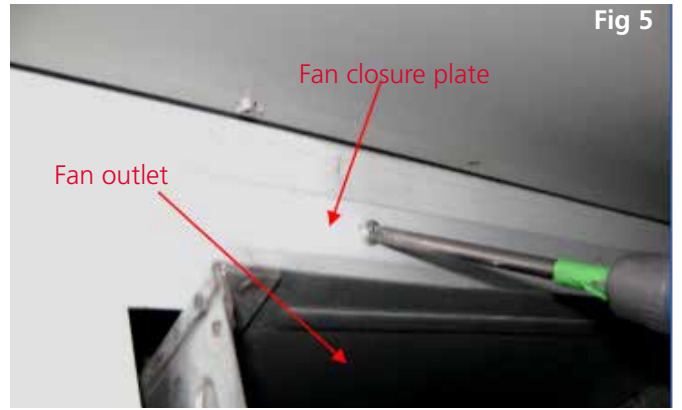

Fig 5

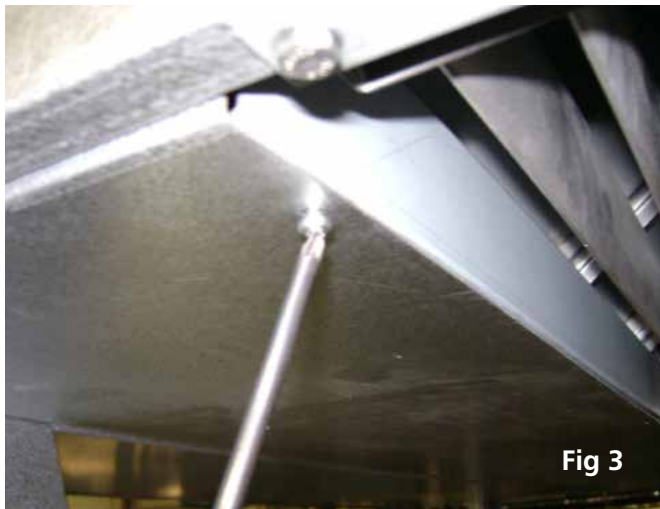

Fig 3

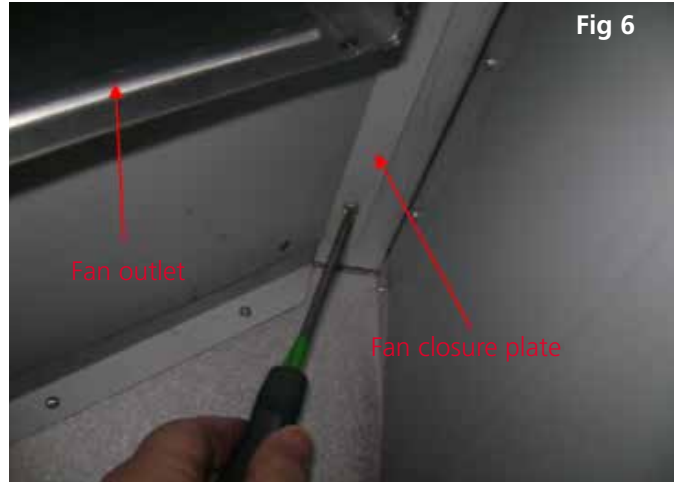

Fig 6

The lid can now be hinged down to access the fans as shown in Fig.4.

6.2.1 Fan closure plate

Before individual fans can be removed it will be necessary to remove the fan closure plate. Remove the retaining screws around the perimeter of the plate. (See Figs.5/6) The plate can now be removed.

6.2.2 Fan removal

Identify the feed cable for the fan requiring removal and disconnect it from its cable mounted plug/socket. (See Fig.7)

The four bolts securing the fan can now be removed as shown in Fig.8, and the fan removed from the air curtain downwards.

CAUTION: These fan units are heavy.



Fig 4



Fig 7



Fig 8

Fig. 9 Shows single air distribution fan insulation for clarity.



Fig 9

Remove the 2 screws (B) retaining the top element plate ends.

Remove the 3 screws (C) retaining the top rail of the element assembly.

The element assembly can now be tilted forward slightly and lifted from the 3 retaining tab slots (D). See diagram 8.

The wiring to the element assembly can now be accessed at the rear of panel (E), and disconnected after first noting the cable positions.

Finally disconnect the two female spade connectors from the overheat thermostat (F). The element assembly can now be withdrawn from the air curtain.

Refitting a new element assembly is the reverse of the above procedure.

6.3 Heating element removal (see Diagram 7)

To gain access to the elements first remove the 9 screws (A) retaining the element housing.

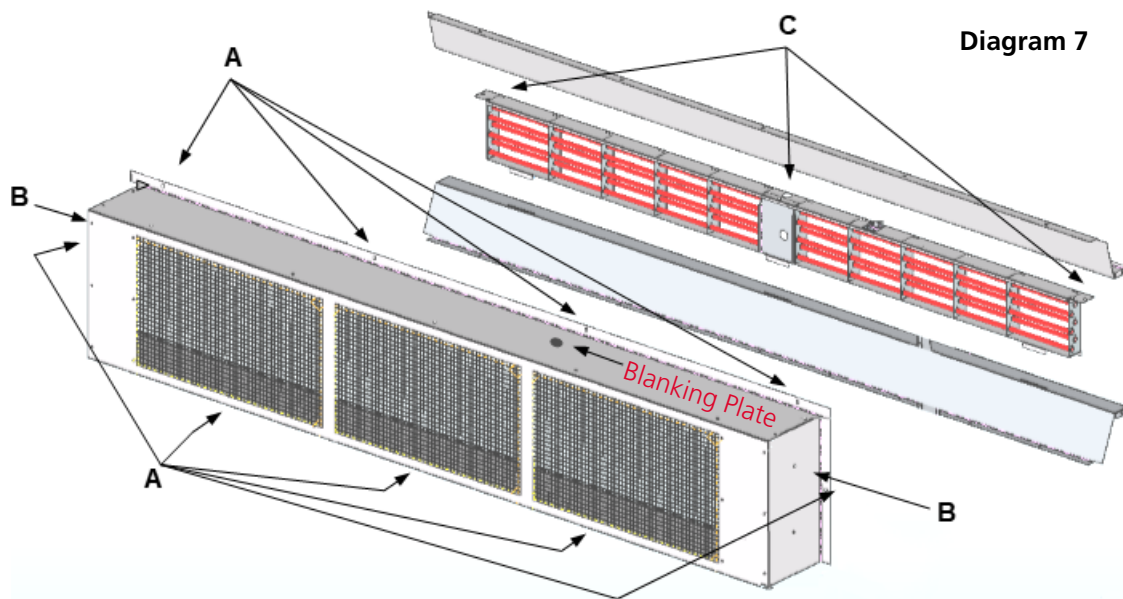

Diagram 7

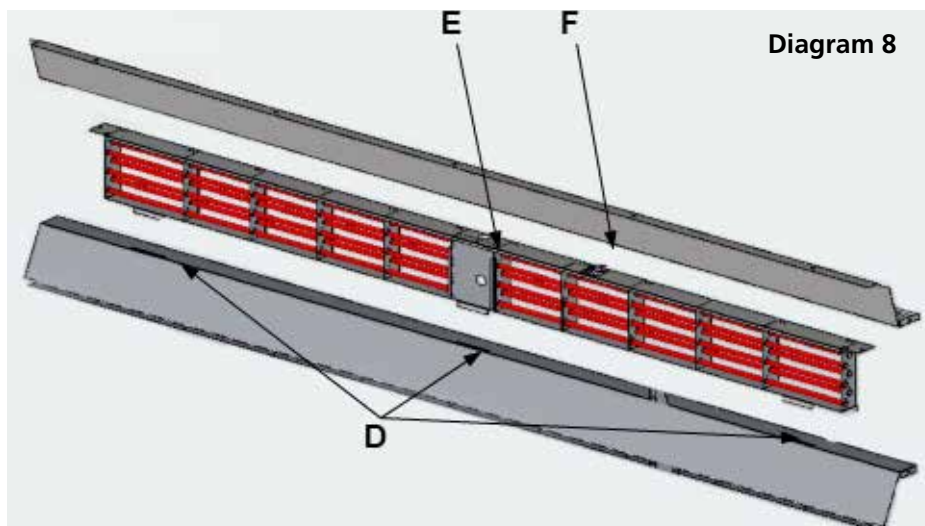
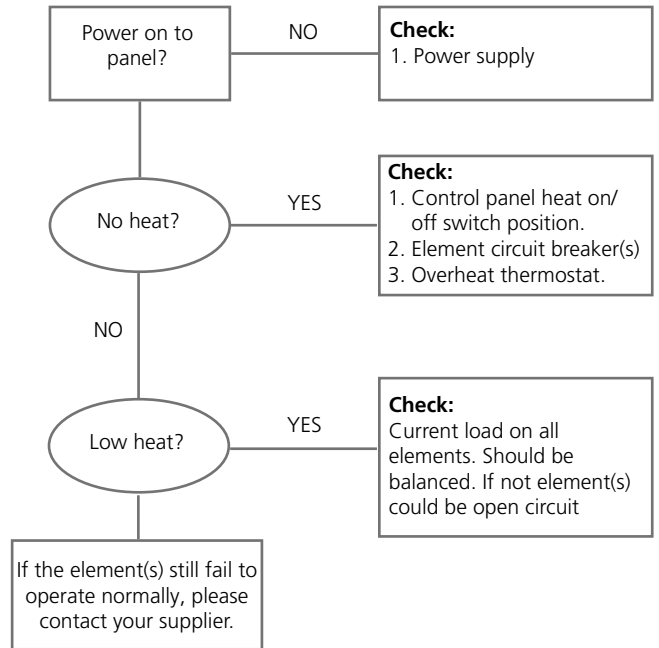

Diagram 8

7. Spare parts

Item	Description	Part No
	3 speed air distribution fan unit	AB-FAN
	AB 225E 24kW elements (full set)	100528
	Thermal cutout (1 per module fitted with electric element)	900001
	Air distribution fan 5 pin plug/ socket	Plug: 3127 Socket: 3126
	AB 175E 18kW elements (full set)	100527

Elements - Electric Heat Models



* If it is determined that the overheat thermostat has tripped it will be necessary to remove the blanking plug located on the top face of the element housing to enable resetting. (See Diagram 7 in section 6 of this manual). This MUST be done with the electrical supply to the air curtain turned OFF.

8. Fault finding

Air distribution fans

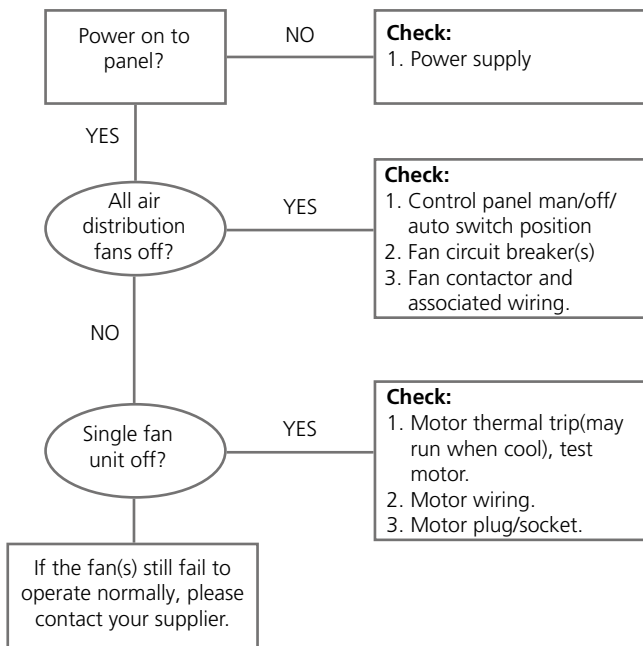

9. User instructions

9.1 Important information

This appliance must only be installed by a competent person in accordance with the requirements of the codes of practice and the rules in force in the country of use.

The appliance must be earthed.

Never rest anything, especially ladders, against the air curtain.

9.2 Control panel

Appearance and function of the control panel will vary depending upon the size and model of air curtain. The image below illustrates a typical control panel for ambient & LPHW models



Ambient & LPHW Models

Auto/Off/Man - In **auto** position the unit will operate via a door interlocked switch (by others) i.e when the door opens the air curtain will work, when the door closes the air curtain will stop. **Man** position will cause the air curtain to operate continuously. **Off** will prevent the air curtain from operating.

Fan speed selector - This allows the user to select the speed of the air leaving the unit depending upon external conditions or individual preference

Electric heated models

On/Off switches the system on or off.

Heat on/off enables the system to run in fan only or heated mode.

An optional room thermostat may be wired into the control panel, this will allow the air curtain to operate as a heater on low fan speed, providing the heat on/off & on/off switches are set to 'on'.

A door interlock switch (by others) will automate the operation of the air curtain on high fan speed, each time the door is opened providing the heat on/off & on/off switches are set to 'on'.

9.3 To start the AB air curtain

- Rotate the control panel on/off (auto/off/man) selector switch to the 'on' position.
- Rotate the fan speed selector switch (if fitted) to the desired position.
- Rotate the heat on/off selector switch (if fitted) to the desired position.
- Switch on electrical supply to the control panel. The panel live lamp will illuminate, the air distribution fans will start and, if selected (or fitted), heating elements will be on.

To start the AB air curtain (BMS control, if specified)

- Rotate the control panel on/off (auto/off/man) selector switch to the 'on' position.
- Rotate the fan speed selector switch (if fitted) to the desired position.
- Rotate the heat on/off selector switch to the desired position (if fitted).
- Switch on electrical supply to the control panel. The panel live lamp will illuminate and the unit will now only operate when the BMS relay or remote switch is closed.
- To switch off the AB air curtain
- Rotate the on/off (auto/off/man) control panel selector switch to the 'off' position.

Servicing

To ensure continued efficient and safe operation it is recommended that the air curtain is serviced regularly by a competent person, once a year in normal working conditions, but in exceptionally dusty or polluted conditions more frequent servicing may be required.



WARNING: This air curtain should not be installed within a corrosive atmosphere.

Sample wiring diagrams

Please note the following wiring diagrams are supplied as a guide only. Wiring diagrams supplied with the control panel MUST be followed as they may include specific control functions/features..

Ambient & LPHW single module

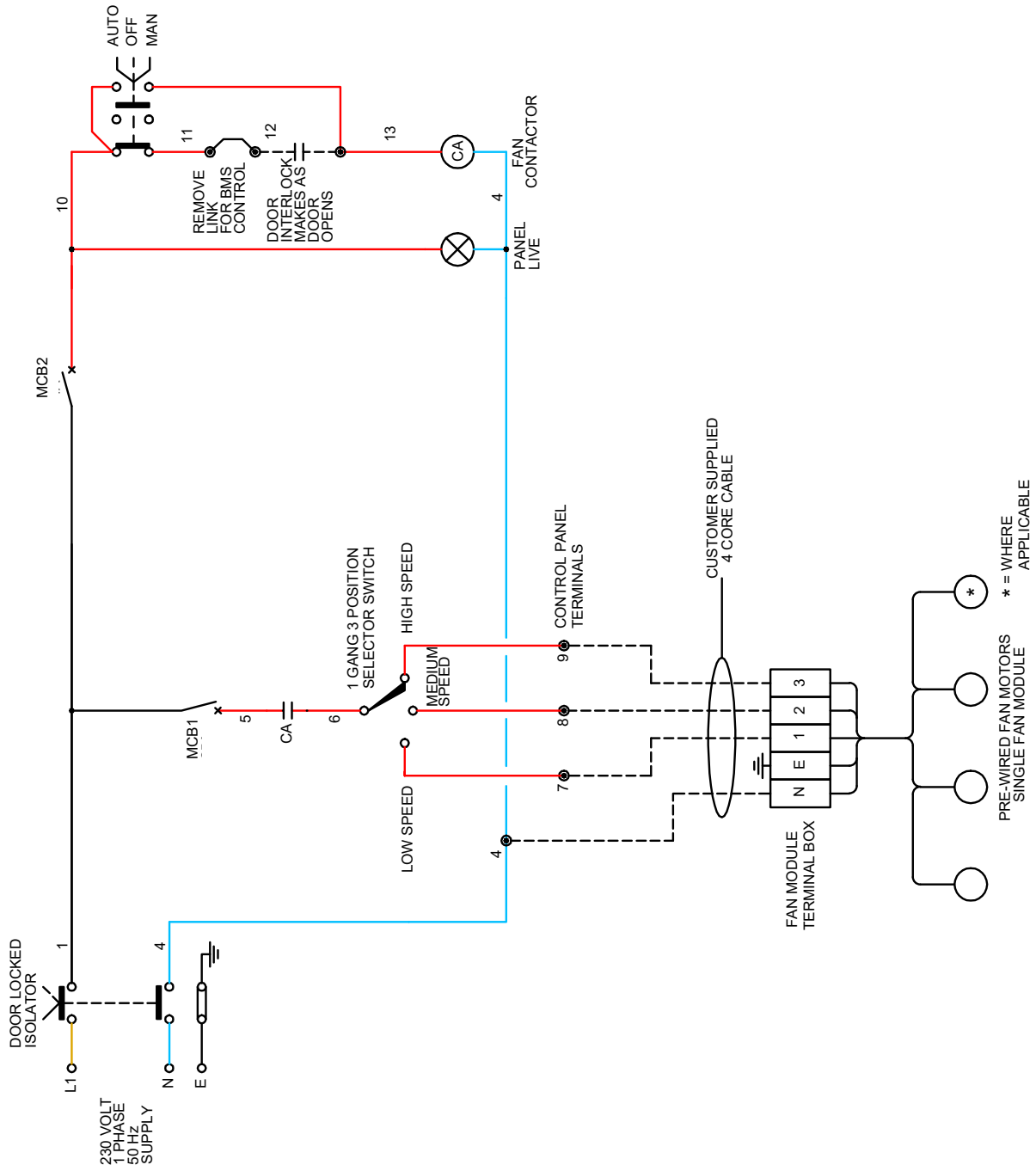

Sample wiring diagrams

Please note the following wiring diagrams are supplied as a guide only. Wiring diagrams supplied with the control panel MUST be followed as they may include specific control functions/features..

Electric Heated Twin module

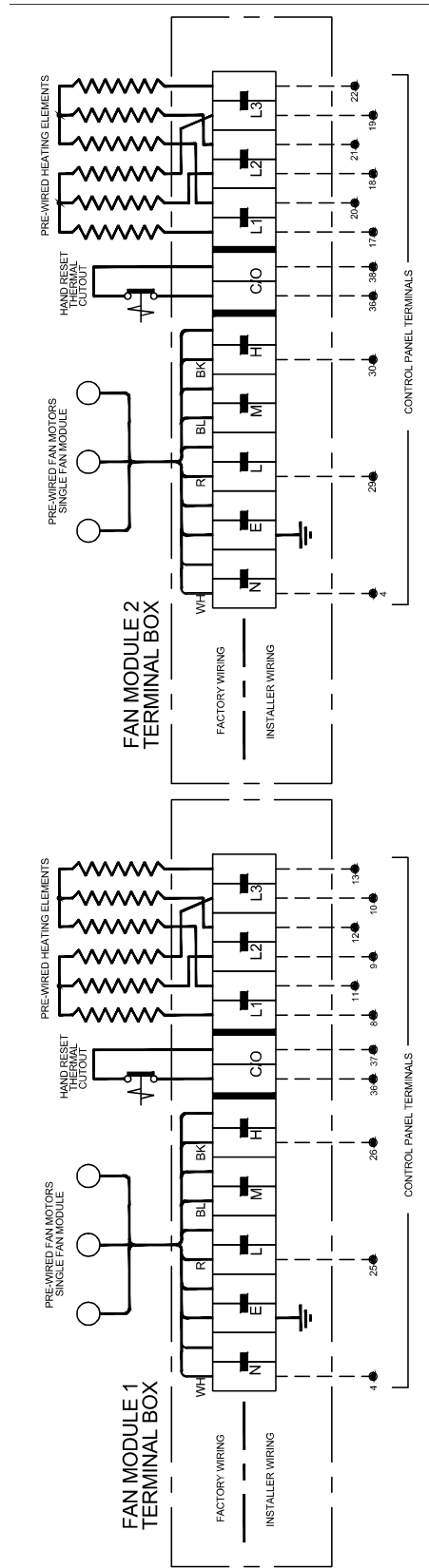
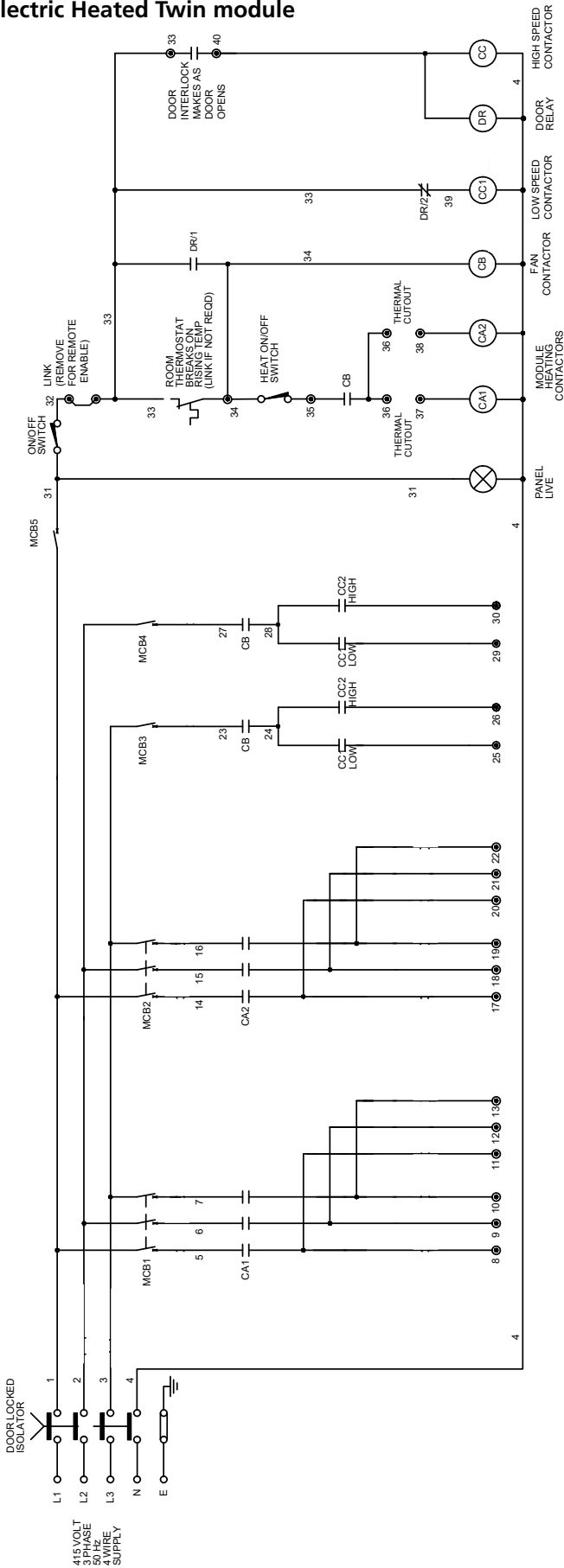



NORTEK GLOBAL HVAC (UK) LTD

Fens Pool Avenue
Brierley Hill
West Midlands DY5 1QA
United Kingdom
Tel +44 (0)1384 489250
Fax +44 (0)1384 489707
reznorsales@nortek.com
www.reznor.eu

Nortek Global HVAC is a registered trademark of the Nortek Global HVAC limited. Because of the continuous product innovation, Nortek Global HVAC reserves the right to change product specification without due notice.