

AIRBLOC AB RANGE

GAS FIRED ROOM SEALED AIR CURTAIN

INSTALLATION AND OPERATING MANUAL

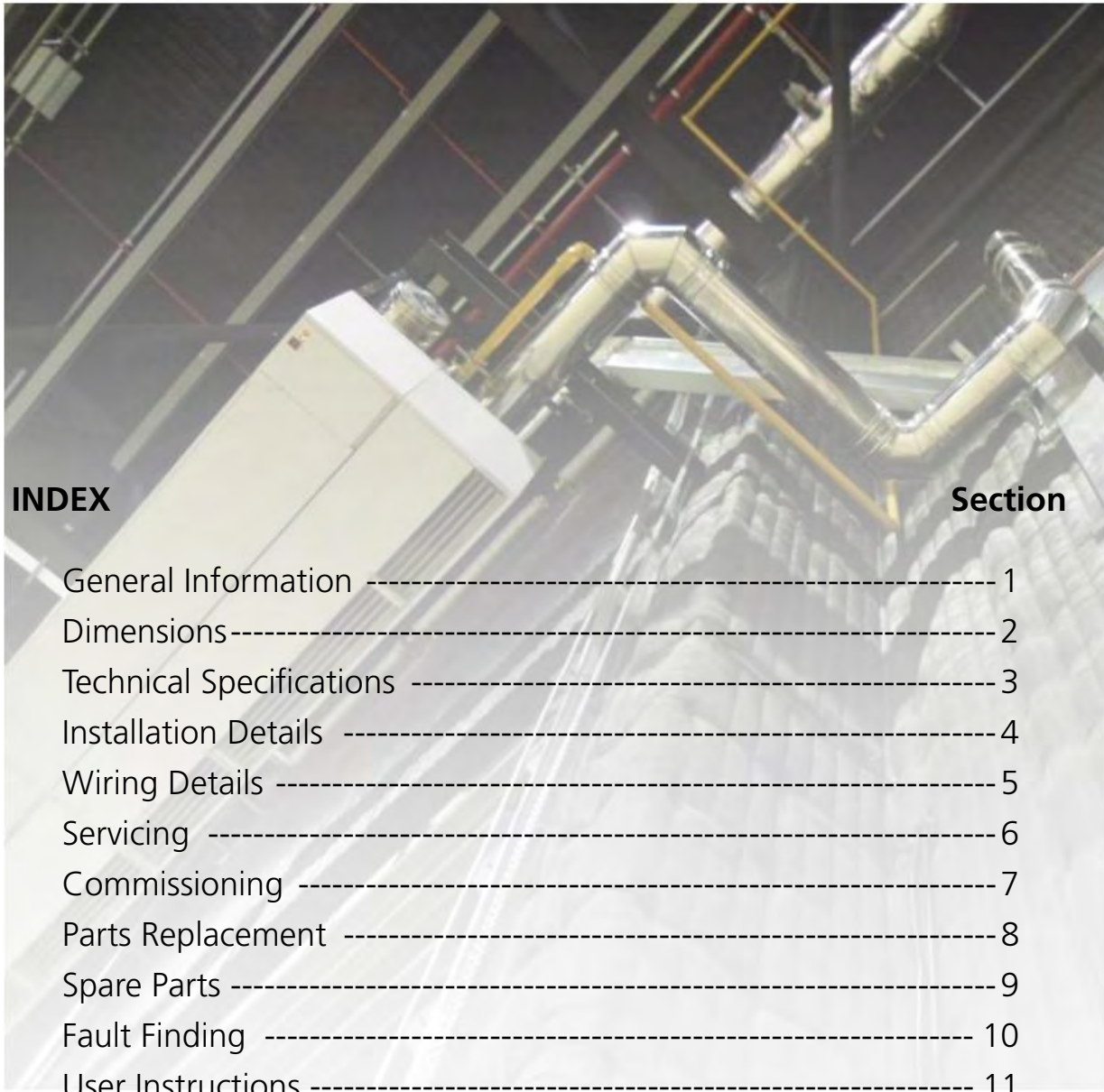

INDEX	Section
General Information -----	1
Dimensions-----	2
Technical Specifications -----	3
Installation Details -----	4
Wiring Details -----	5
Servicing -----	6
Commissioning -----	7
Parts Replacement -----	8
Spare Parts -----	9
Fault Finding -----	10
User Instructions -----	11

WARNINGS

Nortek Global HVAC (UK) Ltd equipment must be installed and maintained in accordance with the relevant provisions of the Gas Safety (Installations and Use) Regulations 1998 for gas fired products. Due account should also be taken of any obligations arising from the Health and Safety at Works Act 1974 or relevant codes of practice. In addition the installation must be carried out in accordance with the current IEE wiring regulations (BS 7671), BS 6896 (Industrial & Commercial) and any other relevant British Standards and Codes of Practice by a qualified installer. All external wiring MUST comply with the current IEE wiring regulations.

Part No. 702120



1. General Information.

Welcome to the new AB Airbloc gas fired air heater models. Local regulations may vary in the country of use and it is the installers responsibility to ensure that such regulations are satisfied.

All installation, assembly, commissioning and service procedures must be carried out by suitably qualified competent persons to the statutory regulations in the country of use.

These instructions refer to products for use in GB and the IE.

These air heaters are suitable for indoor use only, and designed to operate at an ambient temperature between -15°C and 30°C .

When installing, commissioning and servicing is undertaken on the gas fired air heaters specified in these instructions, due care and attention is required to ensure that working at height regulations are adhered to at the mounting heights specified.



Without air curtain

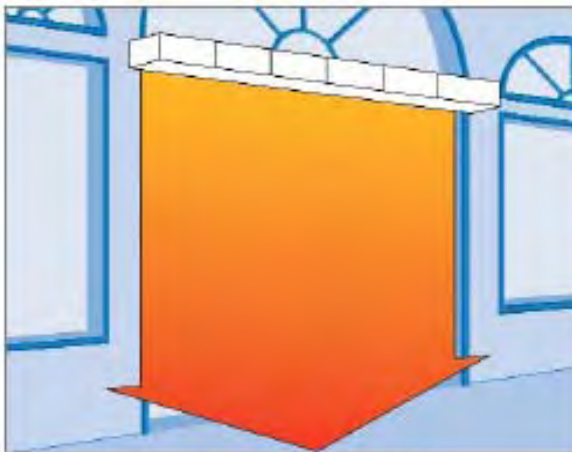

With air curtain

All dimensions shown are in mm unless otherwise stated.

The manufacturer reserves the right to alter specifications without prior notice.

PLEASE READ this document prior to installation to familiarise yourself with the components and tools you require at the various stages.

The primary reason for installing gas fired air heaters is to prevent the influx of cold outside air through a door opening into a heated area.

Typical applications include large despatch bay doors in factories and warehouses, and internal doors between areas of different temperatures.

Wider door openings can be accommodated by bolting two or more units together.

Air heaters control the internal climate by emitting an air stream with enough velocity to meet the floor so creating an air barrier in the door area. To prevent the ingress of outside draughts, the discharge louvre is angled outwards, so that the air leaving the building meets the wind trying to enter, thus deflecting it. (See diagrams below).

Airbloc gas fired air heaters provide uniform air distribution across the full width of the door, keeping heated or conditioned air inside the building and stopping the ingress of cold air, draughts, and dust.

This manual provides detailed information on the installation of Airbloc gas fired air heaters. It is essential that these products are installed in accordance with these manufacturers instructions.

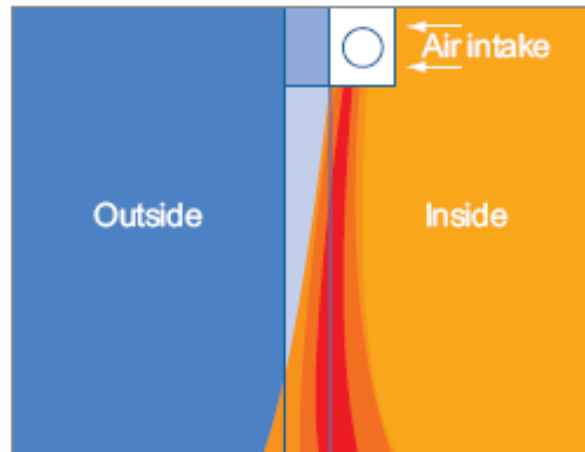

Pattern of airflow

2. Dimensions.

Diagram 1: Dimensions (AB 625 shown)

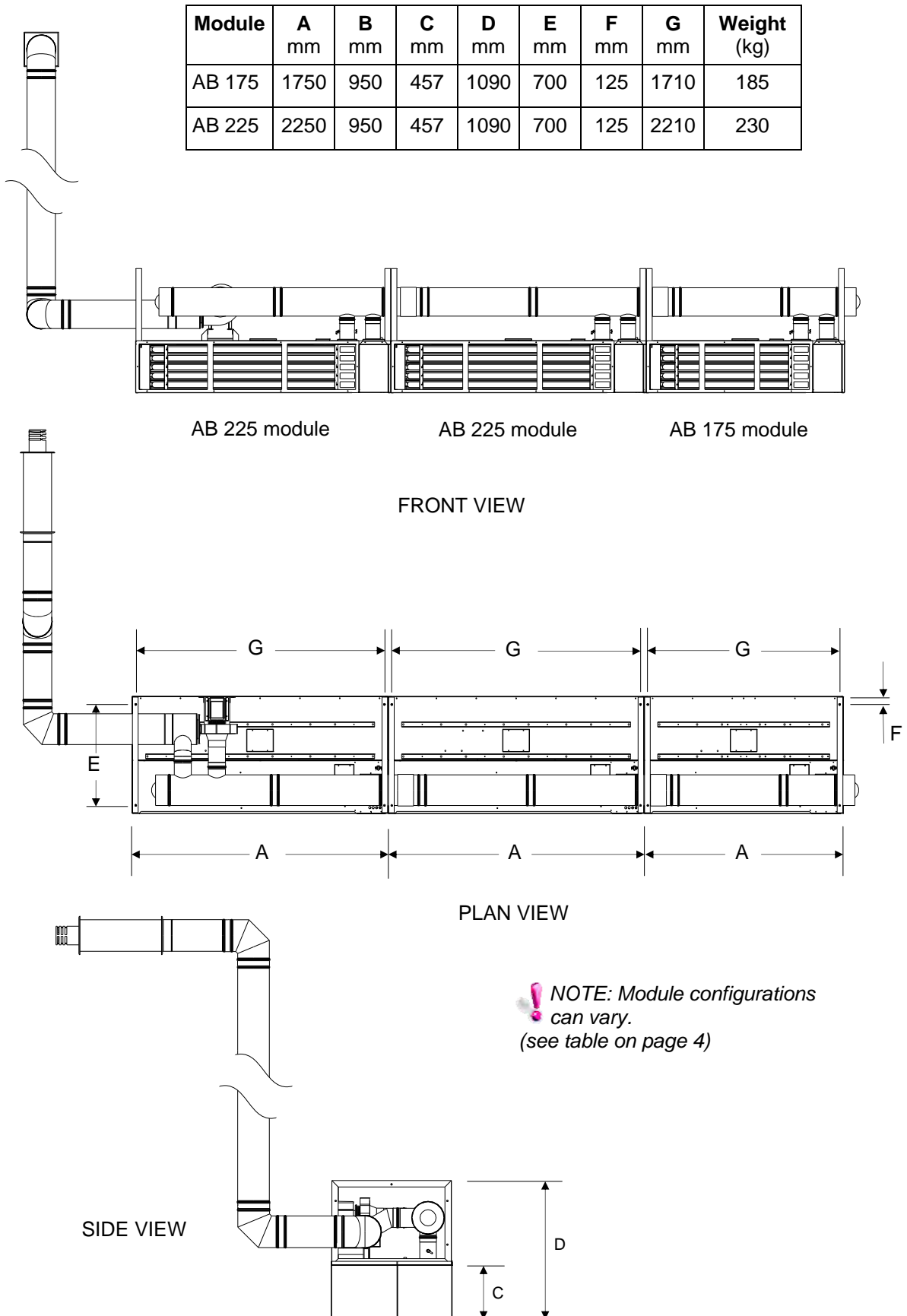

3. Technical Specifications.

	Air heater model ABxxxxRS					
	AB 225N	AB 175N	AB 225N	AB 175N	AB 225P	AB 175P
Gas type	Natural gas G20 (I _{2H})		Natural gas G25 (I _{2L})		Propane G31 (I _{3P})	
Gas connection	½ " BSP external thread					
Max supply pressure (mbar)	25		30		45	
Min supply pressure (mbar)	17		20		25	
Nominal pressure (mbar)	20		25		37	
Gross heat input (kW)	66	49	66	49	65	49
Nett heat input (kW)	59.4	44.1	59.4	44.1	60.2	45.4
Gross heat output (kW)	60.1	44.6	60.1	44.6	59.2	44.6
Nett heat output (kW)	54.0	40.1	54.0	40.1	54.8	41.3
Gas flow rate (m ³ /hr)	6.3	4.7	7.4	5.4	-	-
Gas flow rate (l/hr)	-	-	-	-	9.4	7.0
No. of injectors	5					
Injector size (mm)	Ø3.3	Ø2.9	Ø3.3	Ø2.9	Ø1.85	Ø1.65
Injector pressure (mbar)	7.5	7.0	10	10	25	25
Flue nominal bore (mm)	130					

Air distribution fans

Type	Centrifugal (with integral thermal trip)					
Speeds	3					
No. of fans	4	3	4	3	4	3
Maximum air volume	9600m ³ /hr (AB 175)				12800m ³ /hr (AB 225)	
Voltage	230V 1PH 50Hz					
Power rating (per fan)	1140 W					
Current (per fan)	5.2A (FLC)					
Start current (per fan)	12A					

Constitution

Model	AB175	AB225
AB350=	X 2	
AB400=	X 1	X 1
AB450=		X 2
AB525=	X 3	
AB575=	X 2	X 1
AB625=	X 1	X 2
AB675=		X 3



WARNING:

THIS AIR CURTAIN SHOULD NOT BE INSTALLED WHERE THERE IS A CORROSIVE ATMOSPHERE.

4. Installation Details.

Health and Safety

Airbloc air heaters must be installed in accordance with the relevant provisions of the Gas Safety (Installations and Use) Regulations 1998. Due account should also be taken of any obligations arising from the Health and Safety at Work Act 1974 or relevant codes of practice. In addition the installation must be carried out in accordance with the current IEE wiring regulations (BS 7671), BS 6896 (Industrial & Commercial) and any other relevant British Standards and Codes of Practice by a qualified installer. Isolate all electrical supplies to the heater & control panel before proceeding.

For your own safety we recommend the use of personal protective equipment when handling this air heater.

Before installation, check that the local distribution conditions, nature of gas and pressure, and the current state of adjustment of the appliance are compatible.

Airbloc gas fired air heaters are supplied with mounting brackets pre-fitted, either as single units, or in multiples, which can be bolted together to suit various door widths.

The minimum mounting height is 1.8 metres (See diagram 2 below).

4.1 Mounting.

Diagram 2.

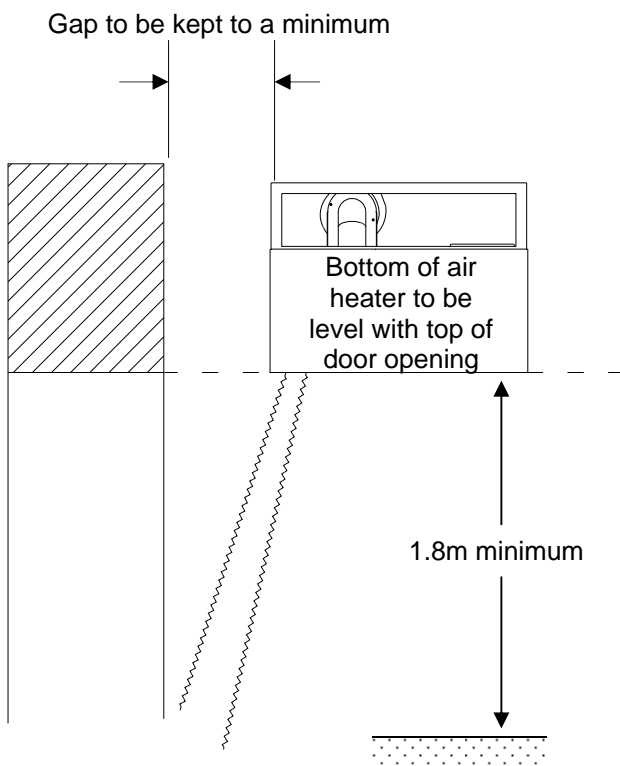

4.1.1

Each single air heater module should be supported by cantilever brackets (not supplied) then fixed back to the building structure by bolting directly using suitable support brackets, or by suspending from above using suitable steelwork. (See diagram 4, page 6).

4.1.2

Multiple air heaters should be bolted together using 3 off M10 set pins, nuts and washers fitted through the holes provided in the mounting brackets, then suitable support channels (not supplied) must be fixed on top of the factory fitted brackets along the full length of the assembled air heaters to spread the load.

The assembly can now be fixed back to the building structure by bolting directly using suitable support brackets, or suspending from above using steelwork. (See diagram 3 page 6). If required, the support channel may be extended slightly past the ends of the air heaters to aid fixing.

Note: Where multiple air heaters are fitted above up and over doors or where central support is inappropriate, the support channel should be replaced with channels of a greater cross section to prevent the assembly from bending.

It may be necessary to adjust the position of the air outlet louvres to provide the correct airflow across the door opening. This can be done by first loosening the four locking pins located two at each end of the louvres (arrowed, Fig. A), then loosening the intermediate locking Allen pins (arrowed, Fig. B). The louvres can now be moved to the desired position and the locking pins re-tightened.

NOTE: The AB 225 model has two pairs of intermediate locking Allen pins, whereas the AB 175 model only has one pair.

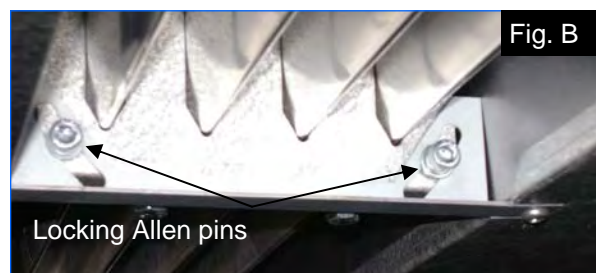
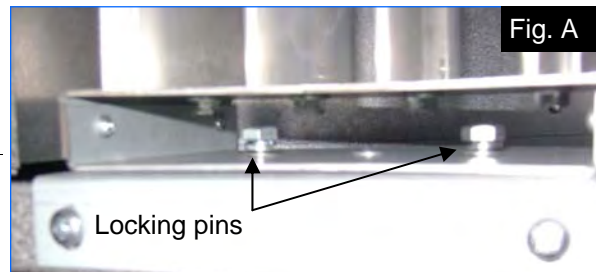

4. Installation Details cont.

Diagram 3: Support channel detail (AB625 shown)

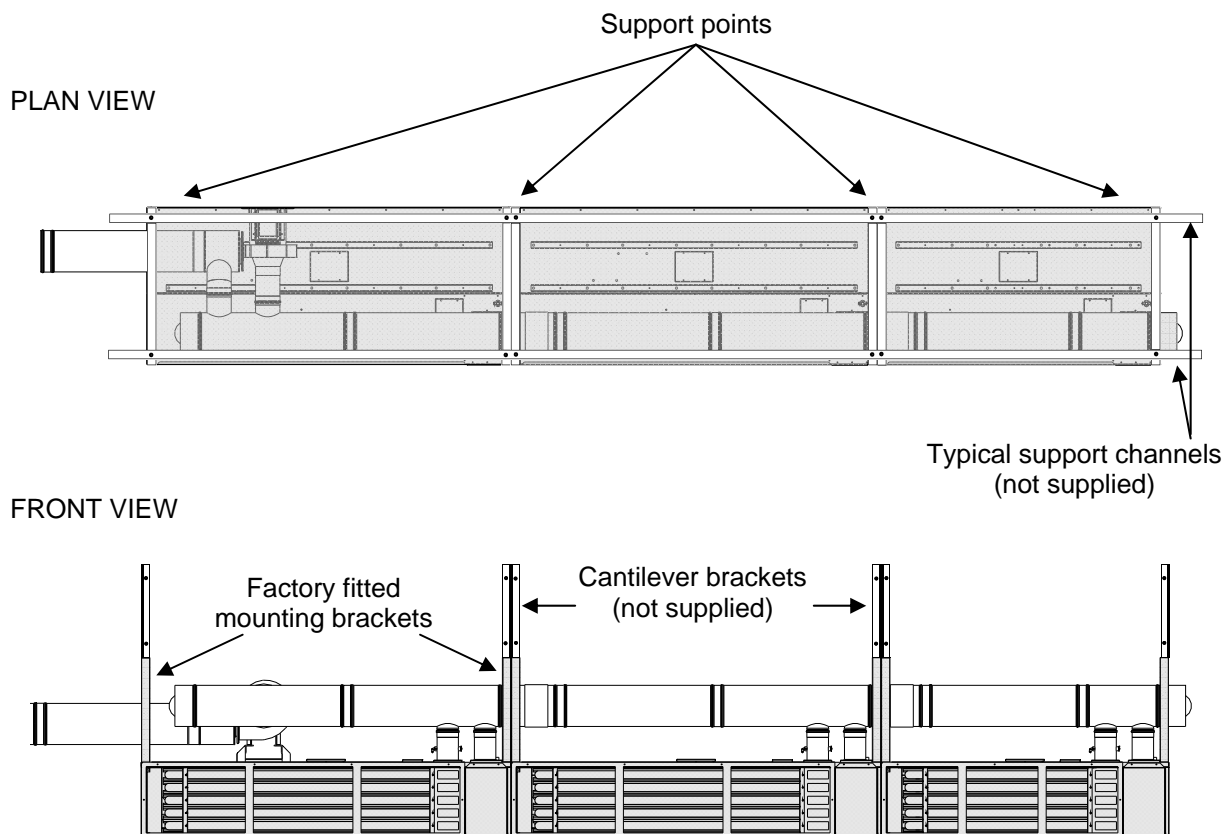

Diagram 4: Cantilever bracket mounting method

Flue technical details.

Model	AB 225		AB 175	
	Natural gas (G20)	Propane (G31)	Natural gas (G20)	Propane (G31)
Gas type	Natural gas (G20)	Propane (G31)	Natural gas (G20)	Propane (G31)
Mass flow rate of Flue gases (kg/s)	0.0340	0.0332	0.0242	0.0283
Flue gas temperature @ flue outlet (°C)	162	173	172.5	182
Flue pressure (Pa) positive	55		49	

4.2 Flueing.

The gas fired air heater must be installed with a fixed flue as supplied by the manufacturer.

The flue pipe should be adequately supported at regular intervals from the building structure and terminated externally.

The maximum flue length is 10m and the maximum number of bends is four. The flue can be terminated horizontally or vertically. (See diagrams 5 and 6A on page 7).

4. Installation Details cont.

Diagram 5: Typical flue arrangement (AB 625 shown)

 Ventilation requirements are detailed in section 4.3.

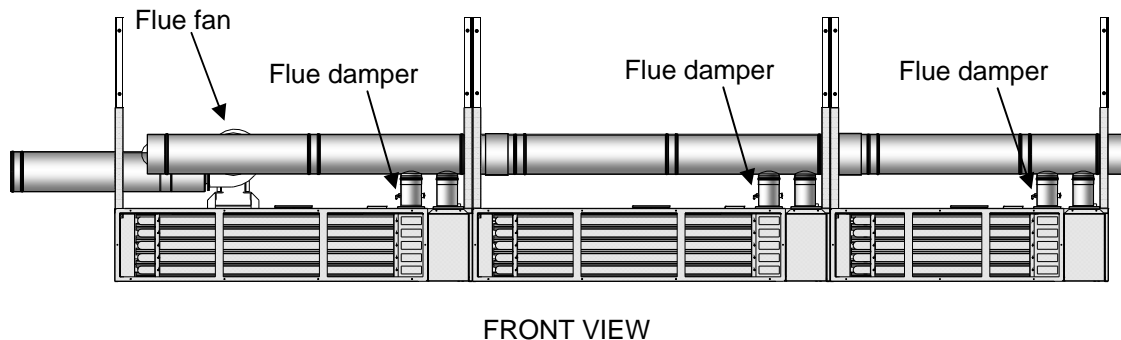

Diagram 6: Typical flue arrangement with horizontal terminal

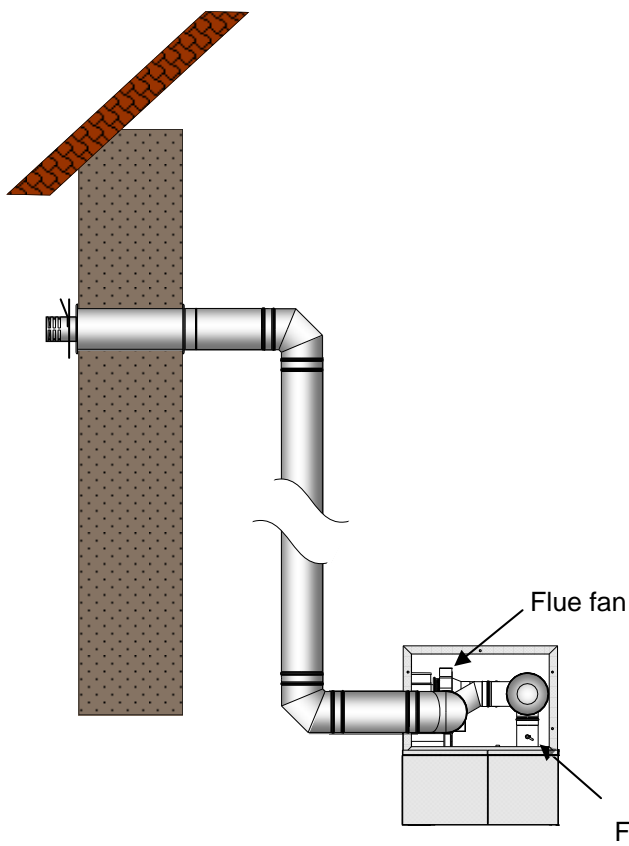
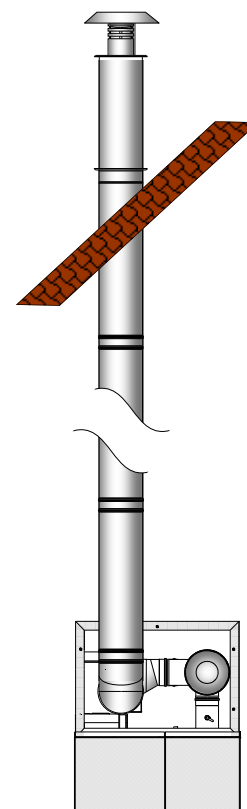

Diagram 6A: Typical flue arrangement with vertical terminal



Note:

When the horizontal flue is to pass through a wall constructed of combustible material, a suitable approved fireproof sleeve should be fitted prior to installing the flue pipe.

4. Installation Details cont.

SUPPLIED FLUE COMPONENTS

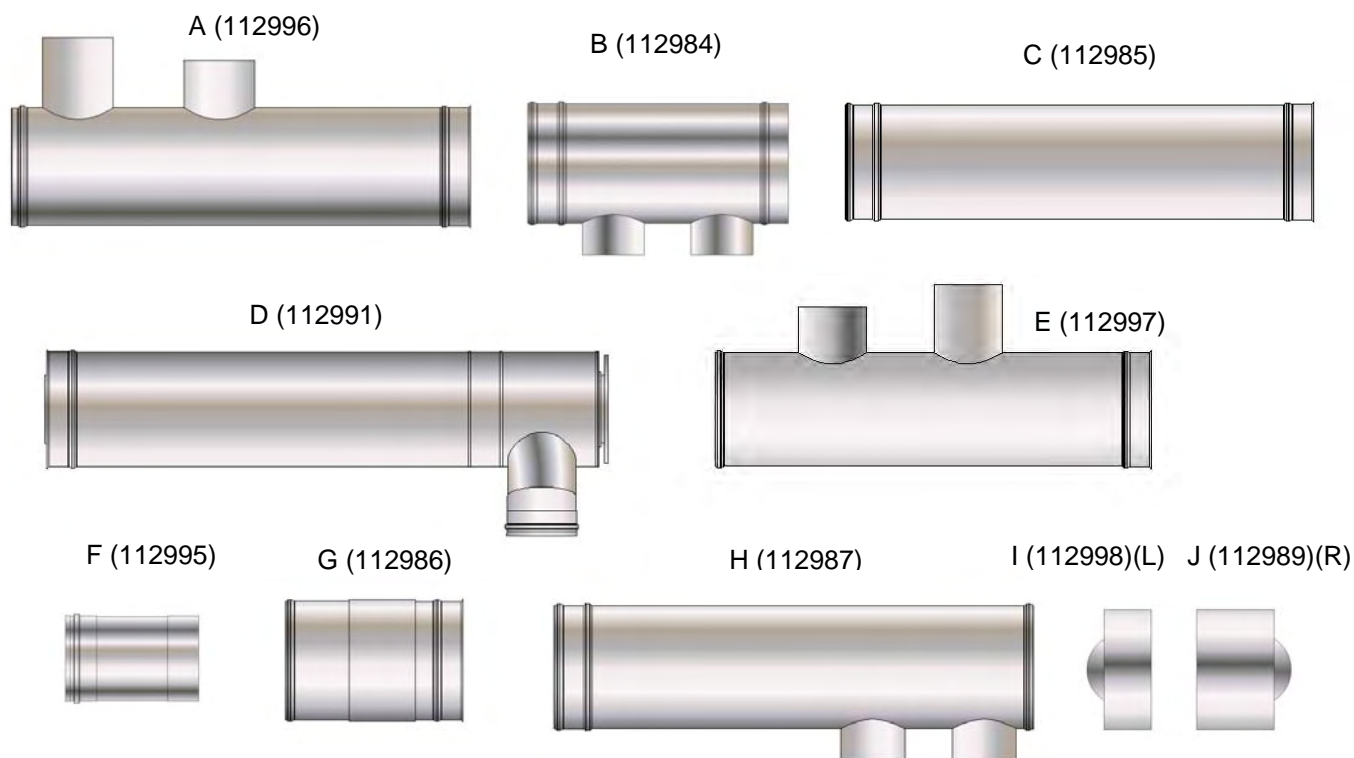

AIR HEATER	MODULES	QUANTITY									
		A	B	C	D	E	F	G	H	I	J
AB350 (LH)	2 x 175	1	2	1	1	-	1	1	-	1	1
AB350 (RH)	2 x 175	-	2	-	1	1	1	1	-	1	1
AB400 (LH) 1	1 x 175 1 x 225	1	1	1	1	-	1	1	1	1	1
AB400 (RH) 1	1 x 175 1 x 225	-	1	-	1	1	1	1	1	1	1
AB400 (LH) 2	1 x 225 1 x 175	1	1	1	1	-	1	1	1	1	1
AB400 (RH) 2	1 x 225 1 x 175	-	2	-	1	1	1	1	-	1	1
AB450 (LH)	2 x 225	1	-	1	1	-	1	1	2	1	1
AB450 (RH)	2 x 225	-	1	-	1	1	1	1	1	1	1
AB525 (LH)	3 x 175	1	3	2	1	-	1	2	-	1	1
AB525 (RH)	3 x 175	-	3	1	1	1	1	2	-	1	1
AB575 (LH)	1 x 175 1 x 225 1 x 175	1	2	2	1	-	1	2	1	1	1
AB575 (RH)	1 x 175 1 x 225 1 x 175	-	2	1	1	1	1	2	-	1	1
AB625 (LH)	1 x 225 1 x 175 1 x 225	1	1	2	1	-	1	2	2	1	1
AB625 (RH)	1 x 225 1 x 175 1 x 225	-	2	1	1	1	1	2	1	1	1
AB675 (LH)	3 x 225	1	-	2	1	-	1	2	3	1	1
AB675 (RH)	3 x 225	-	1	1	1	1	1	2	2	1	1

NOTE: (LH) and (RH) references above refer to flue exit direction.

! Quantities in the table above refer to fittings supplied with the heaters. Extra flue will be required to exit from the building based on individual site requirements. See following pages for optional flue and individual configurations.

4. Installation Details cont.

OPTIONAL FLUE COMPONENTS

524-872mm adjustable (113901)



90 deg. elbow (112992)



45 deg. elbow (113900)



955mm flue length (112985)



Vertical terminal (114174)

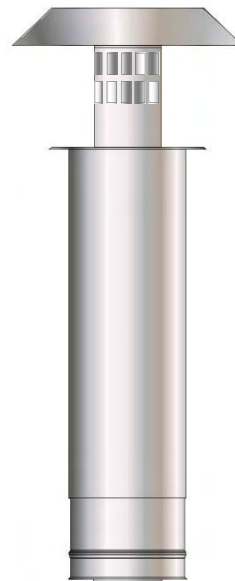

Horizontal terminal (112994)



Wall band 50mm ext (113844)



Wall band extension 300mm (113845)



Wall band extension 50-100mm (113846)

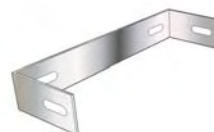

AB 350 LH flue configuration (2 x AB 175)

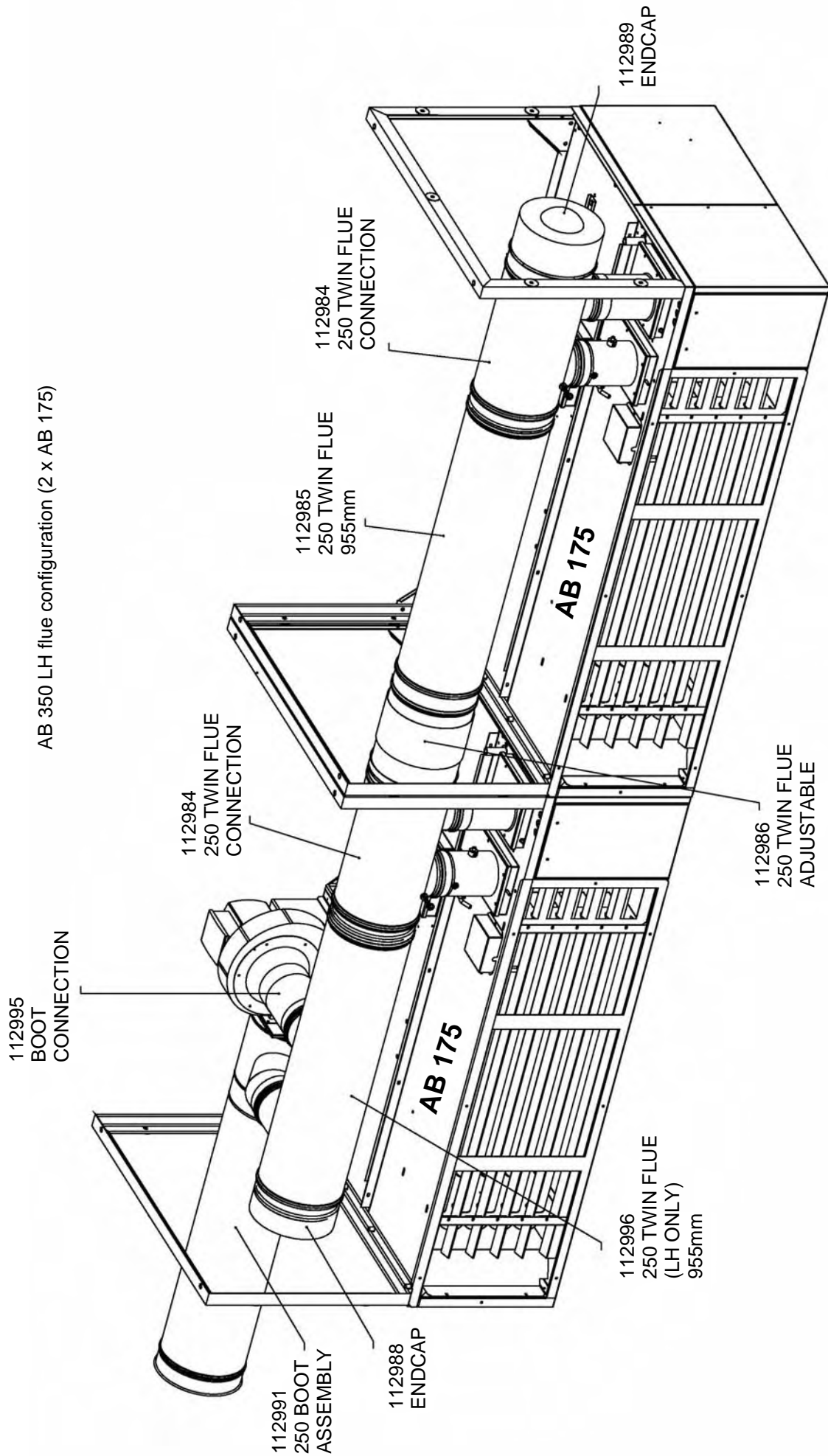

AB 350 RH flue configuration (2 x AB 175)

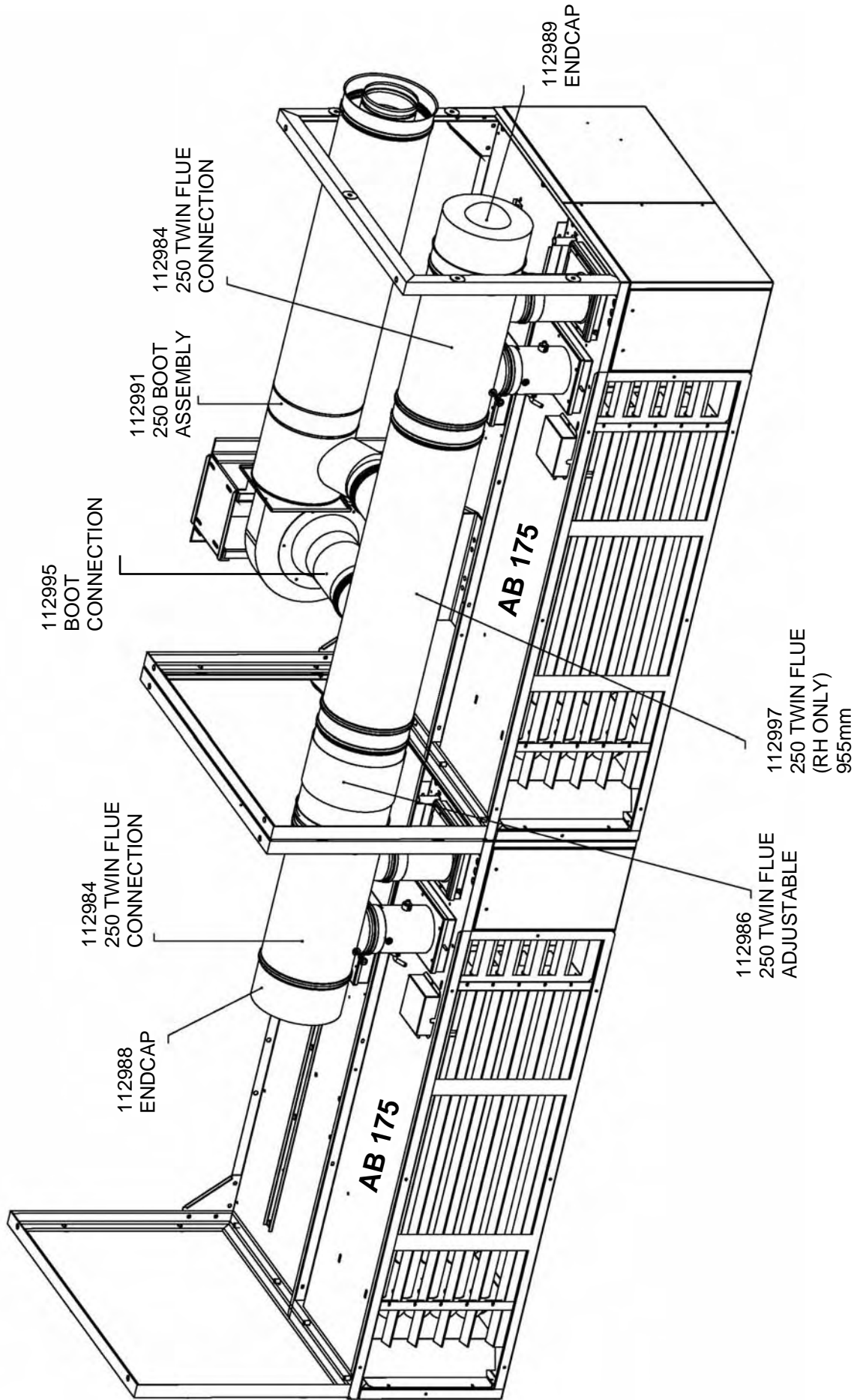

AB 400 LH flue configuration (1 x AB 175 1 x AB 225)

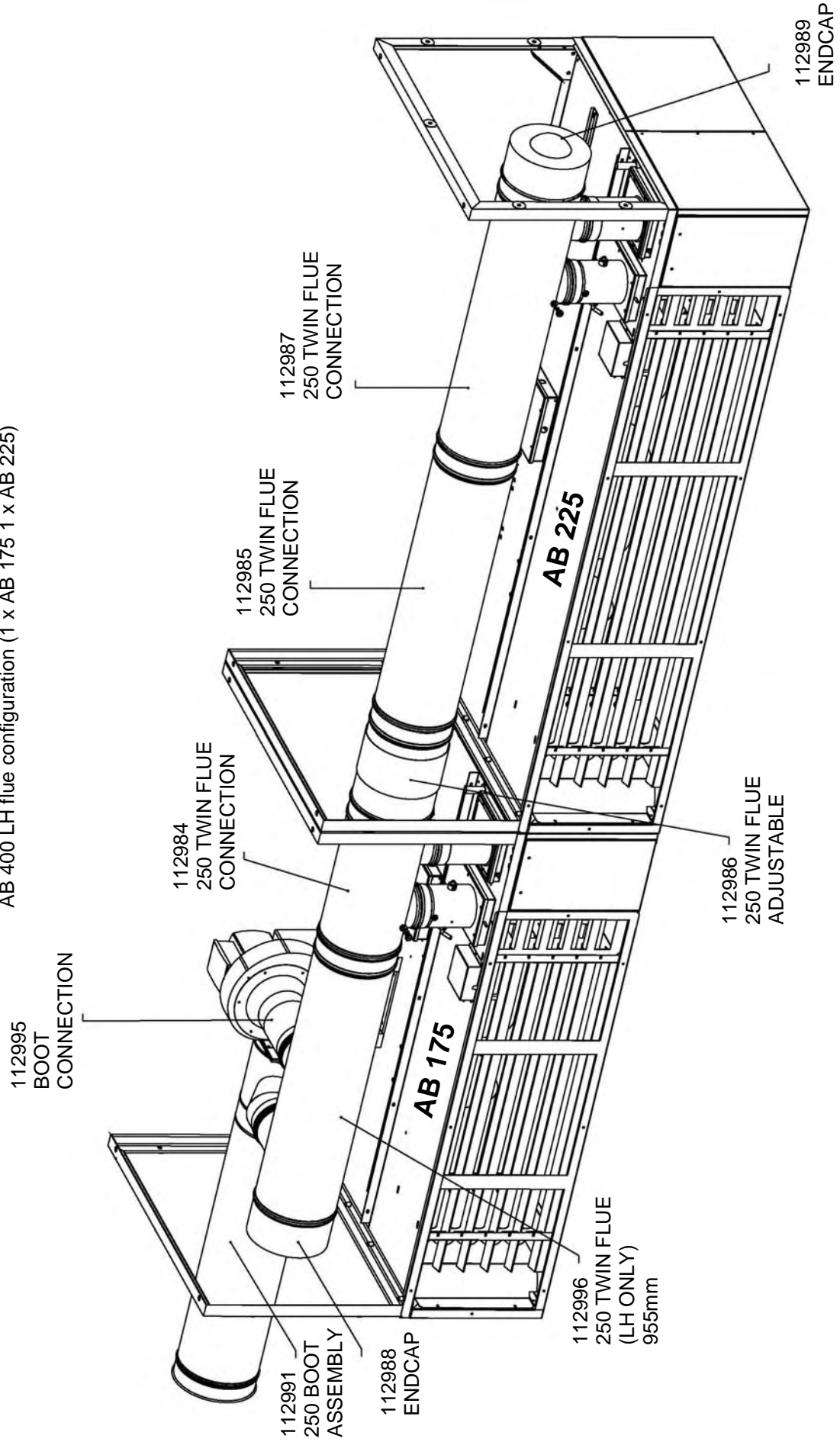

AB 400 RH flue configuration (1 x AB 175 1 x AB 225)

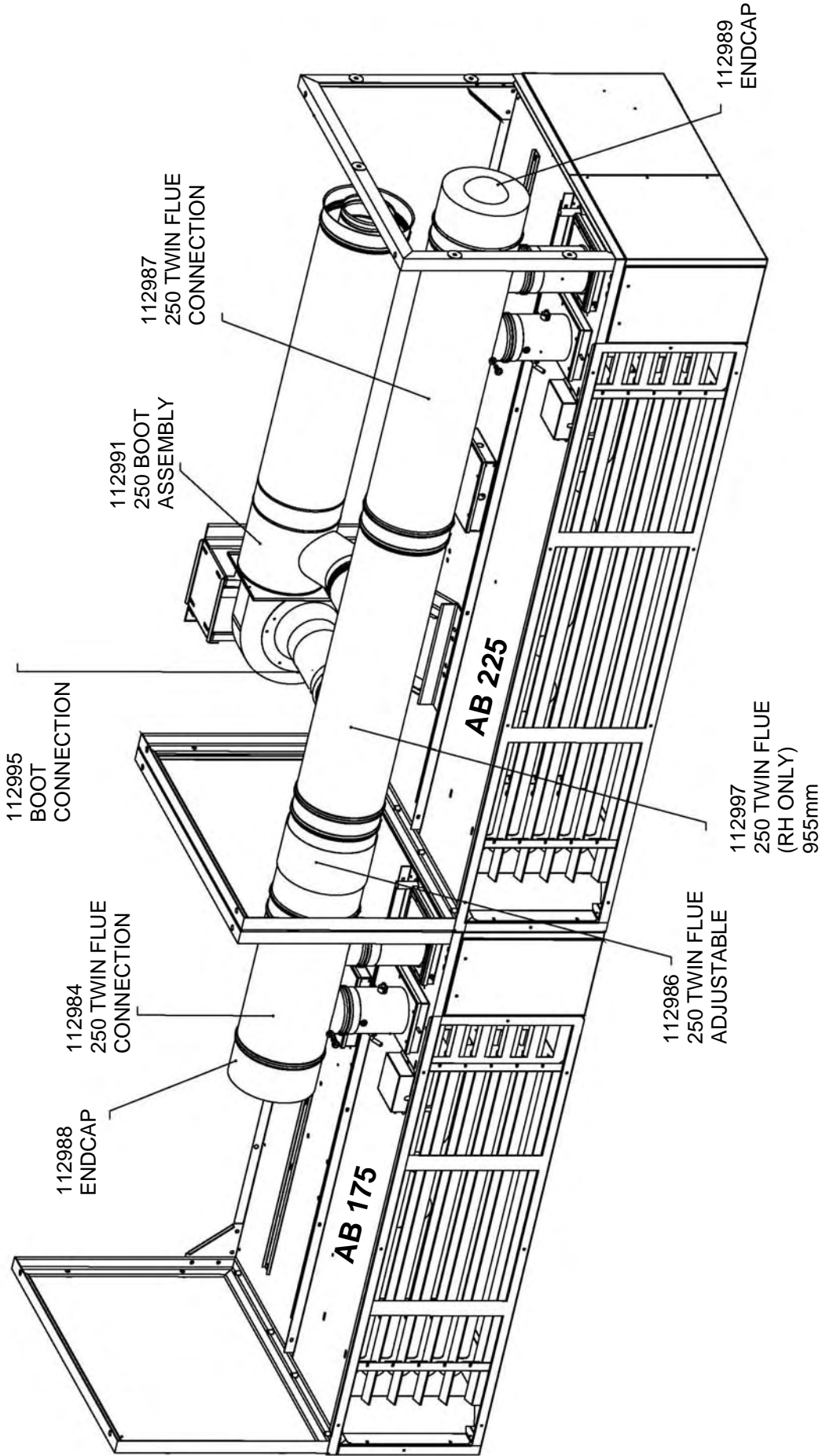

AB 400 LH flue configuration (1 x AB 225 1 x AB 175)

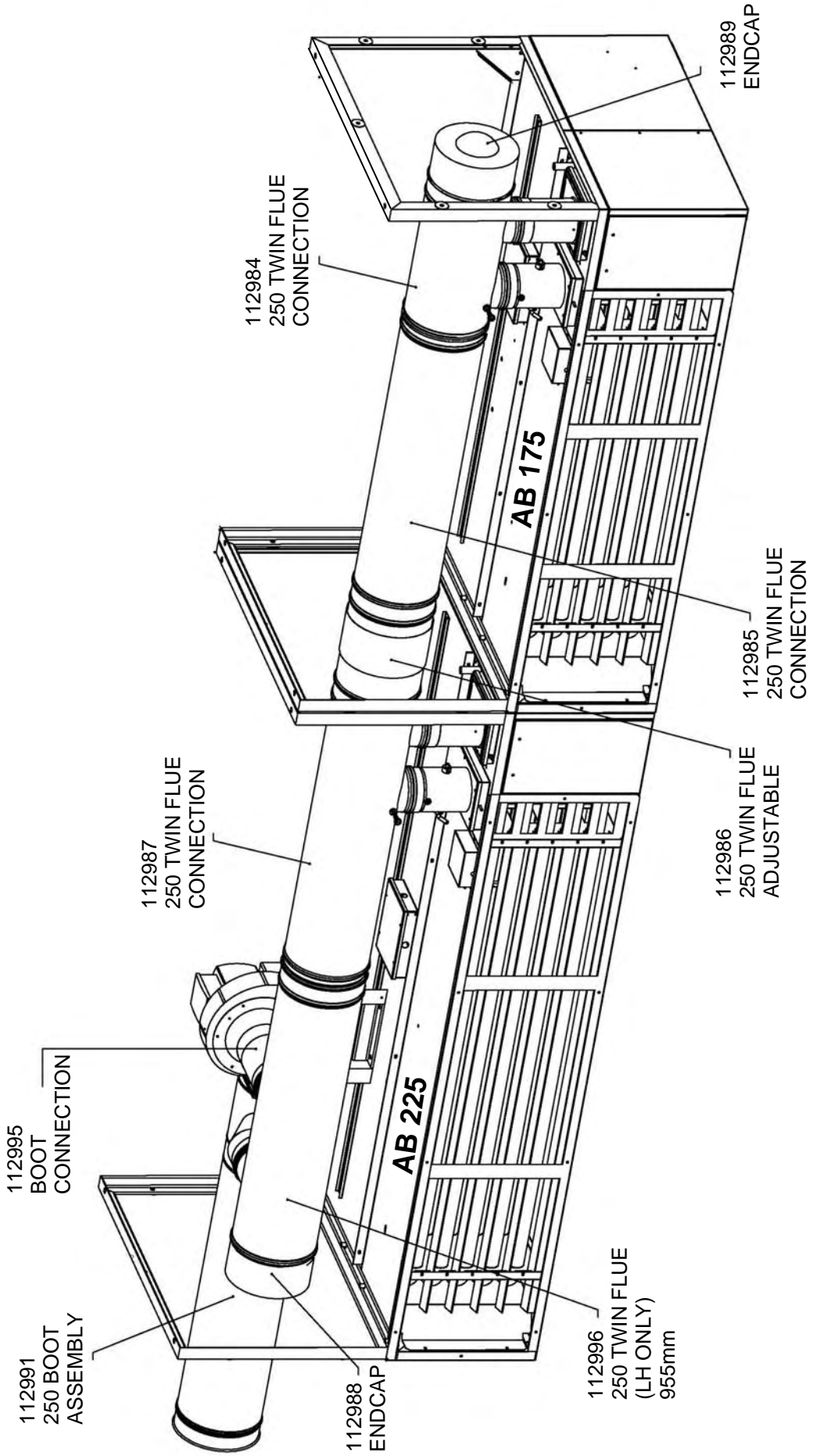

AB 400 RH flue configuration (1 x AB 225 1 x AB 175)

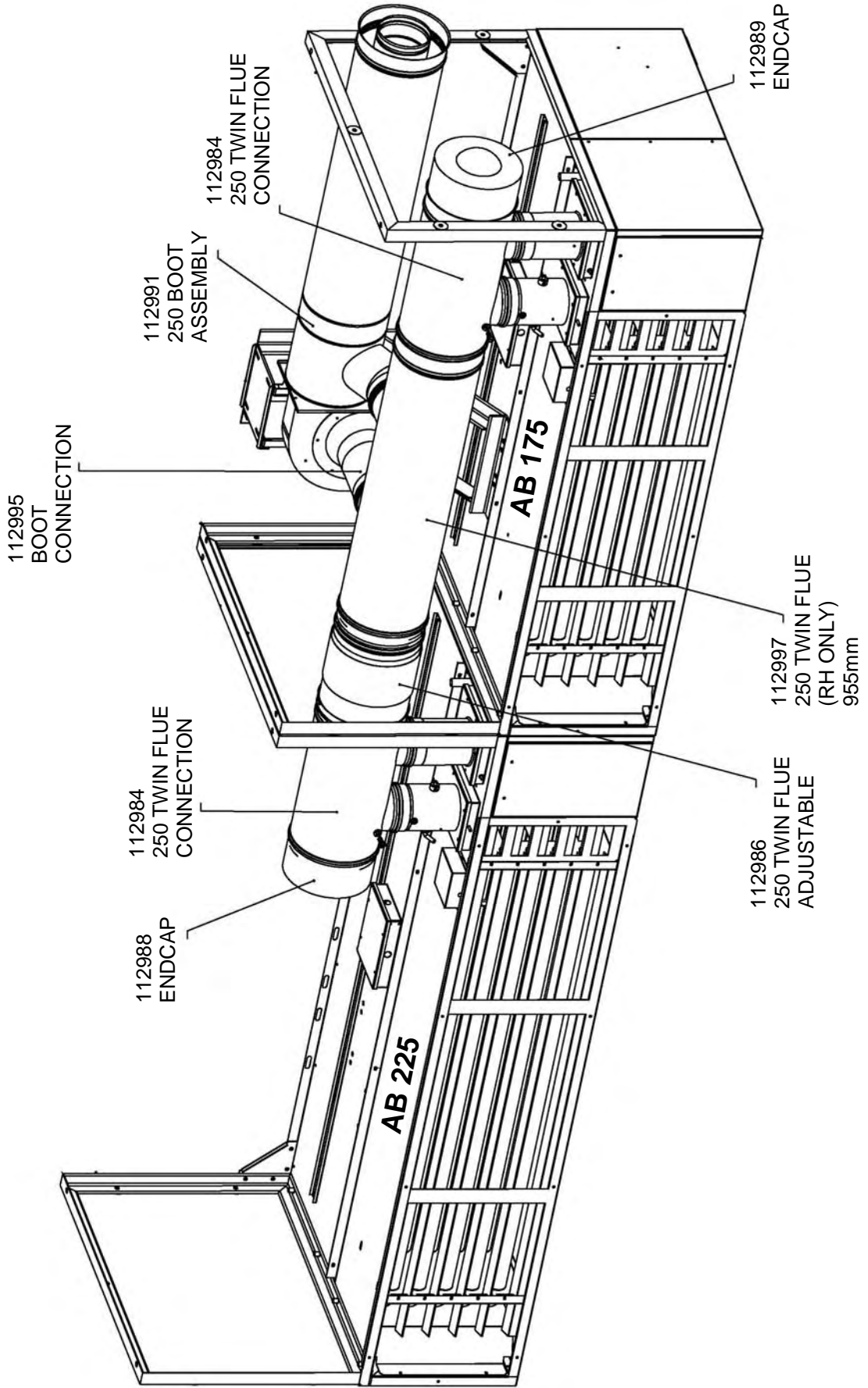

AB 450 LH flue configuration (2 x AB 225)

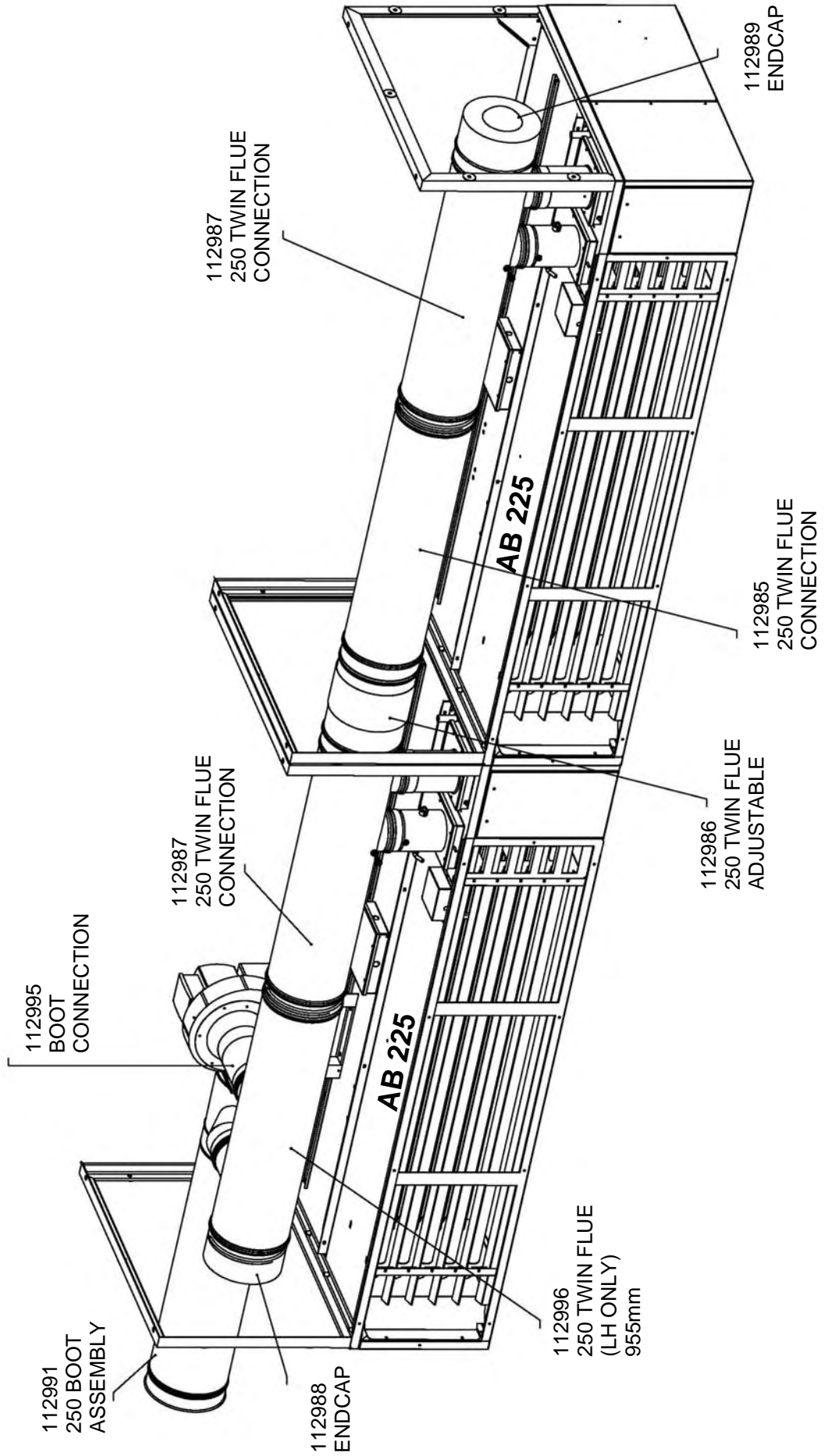

AB 450 RH flue configuration (2 x AB 225)

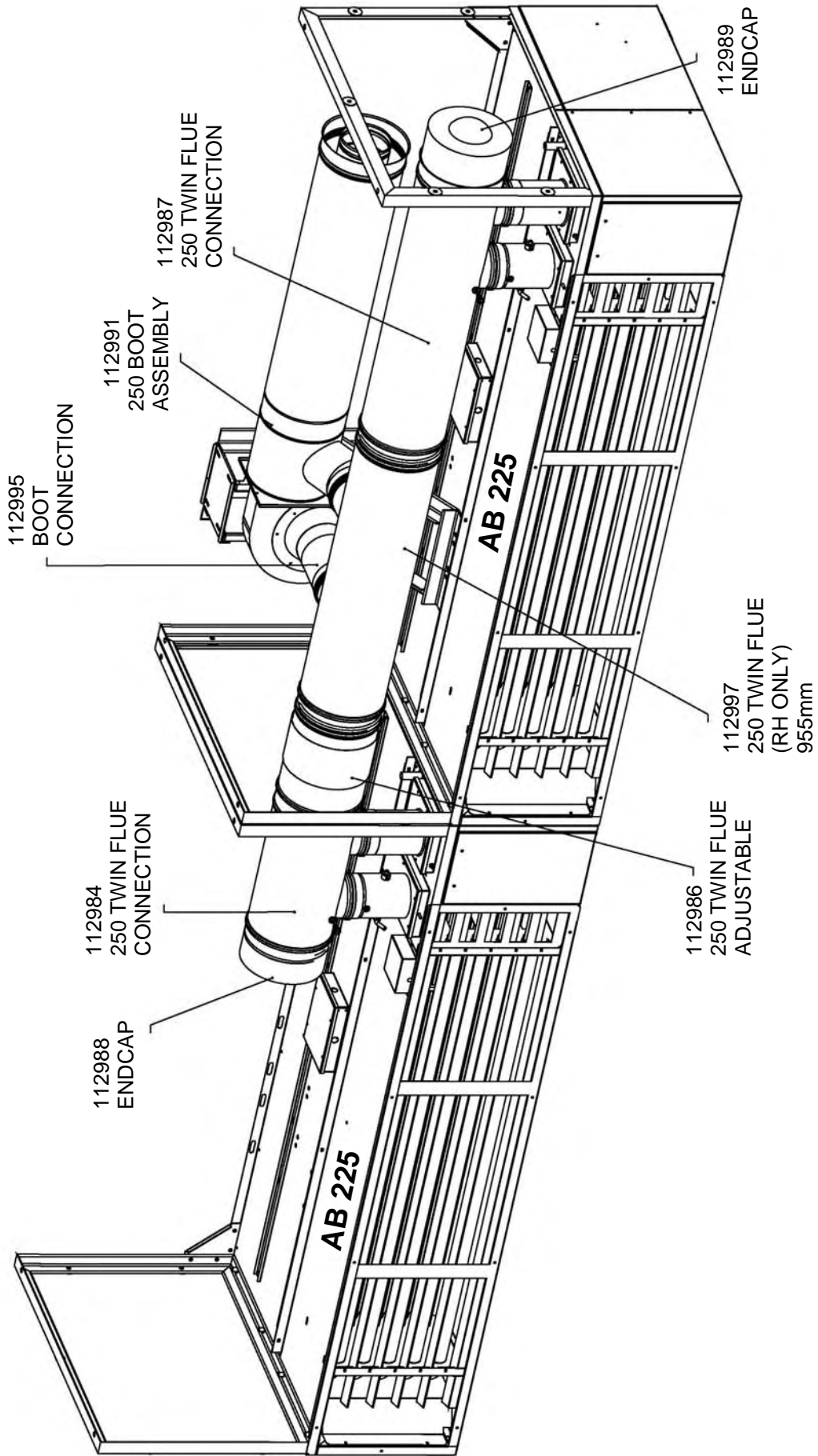

AB 525 LH flue configuration (3 x AB 175)

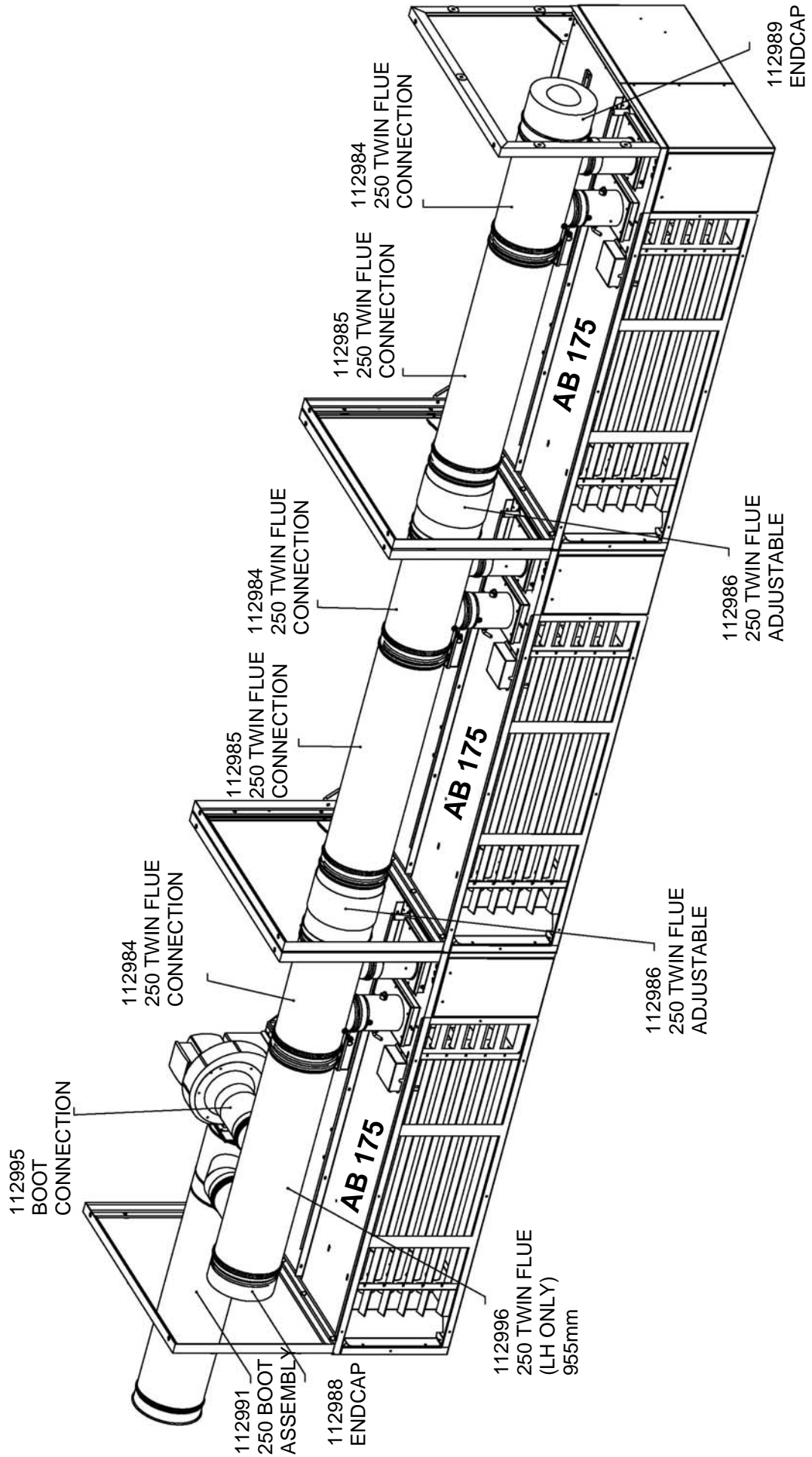

AB 525 RH flue configuration (3 x AB 175)

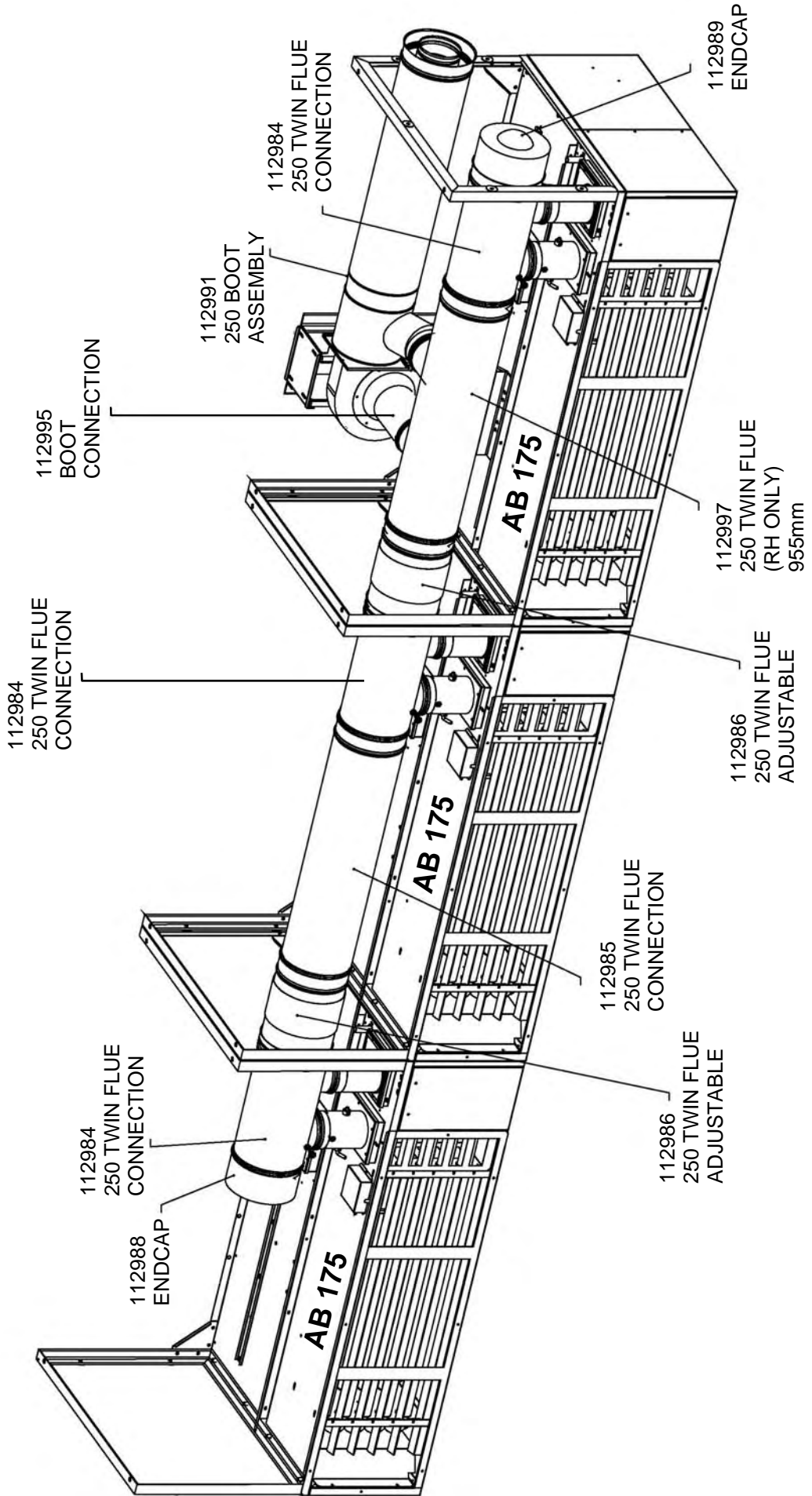

AB 575 LH flue configuration (1 x AB 175 1 x AB 225 1 x AB 175)

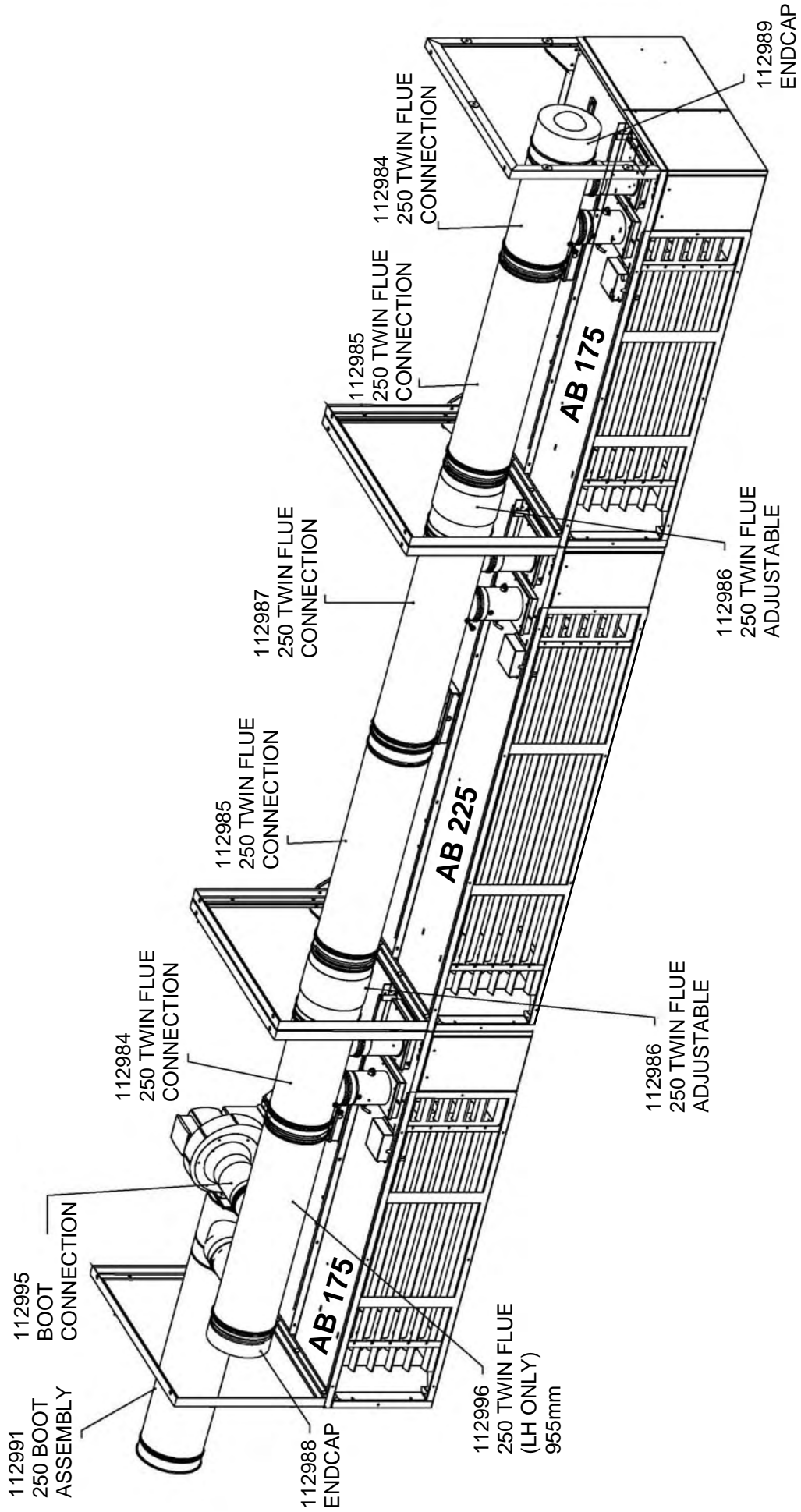

AB 575 RH flue configuration (1 x AB 175 1 x AB 225 1 x AB 175)

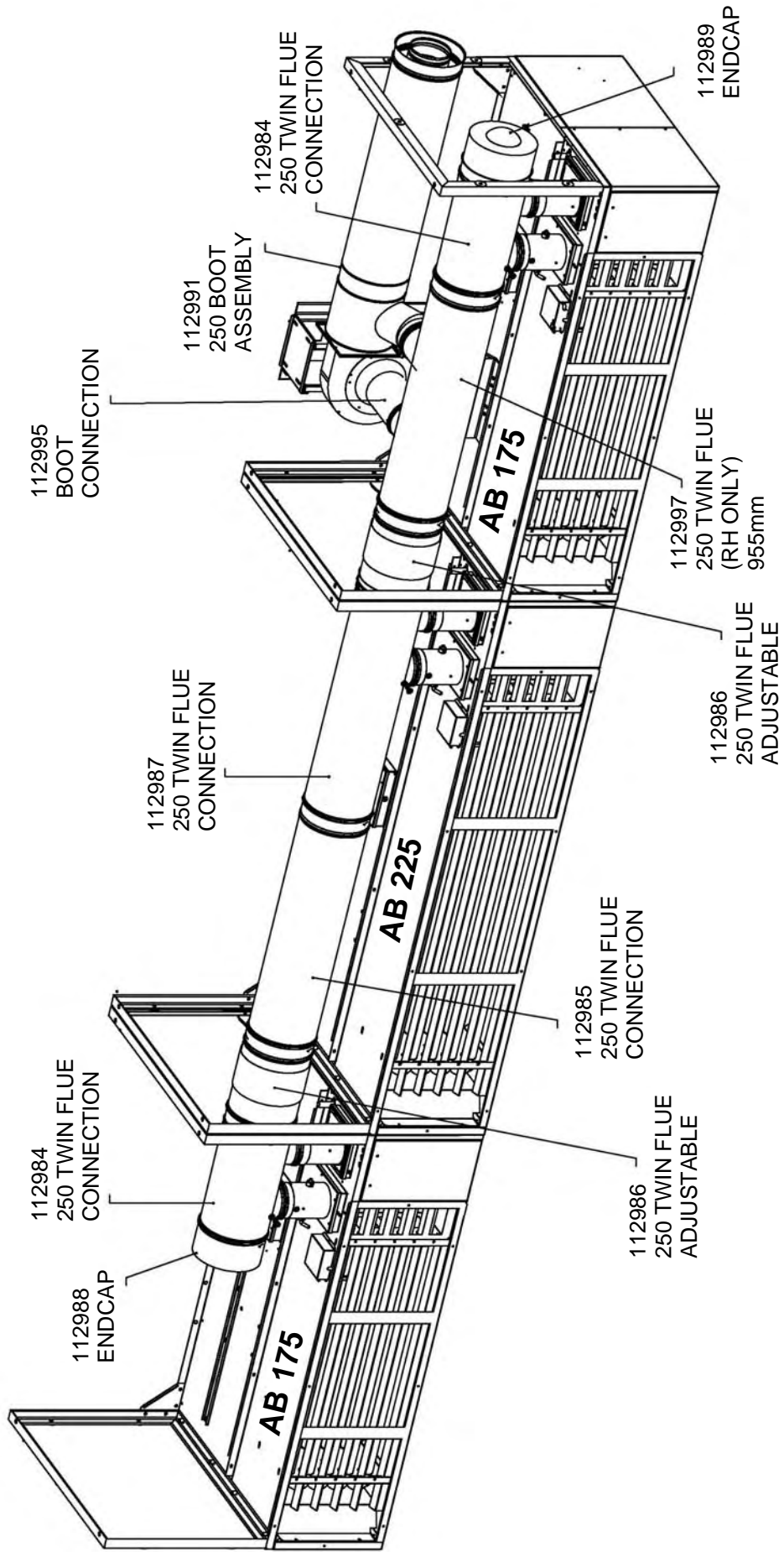

AB 625 LH flue configuration (1 x AB 225 1 x AB 175 1 x AB 225)

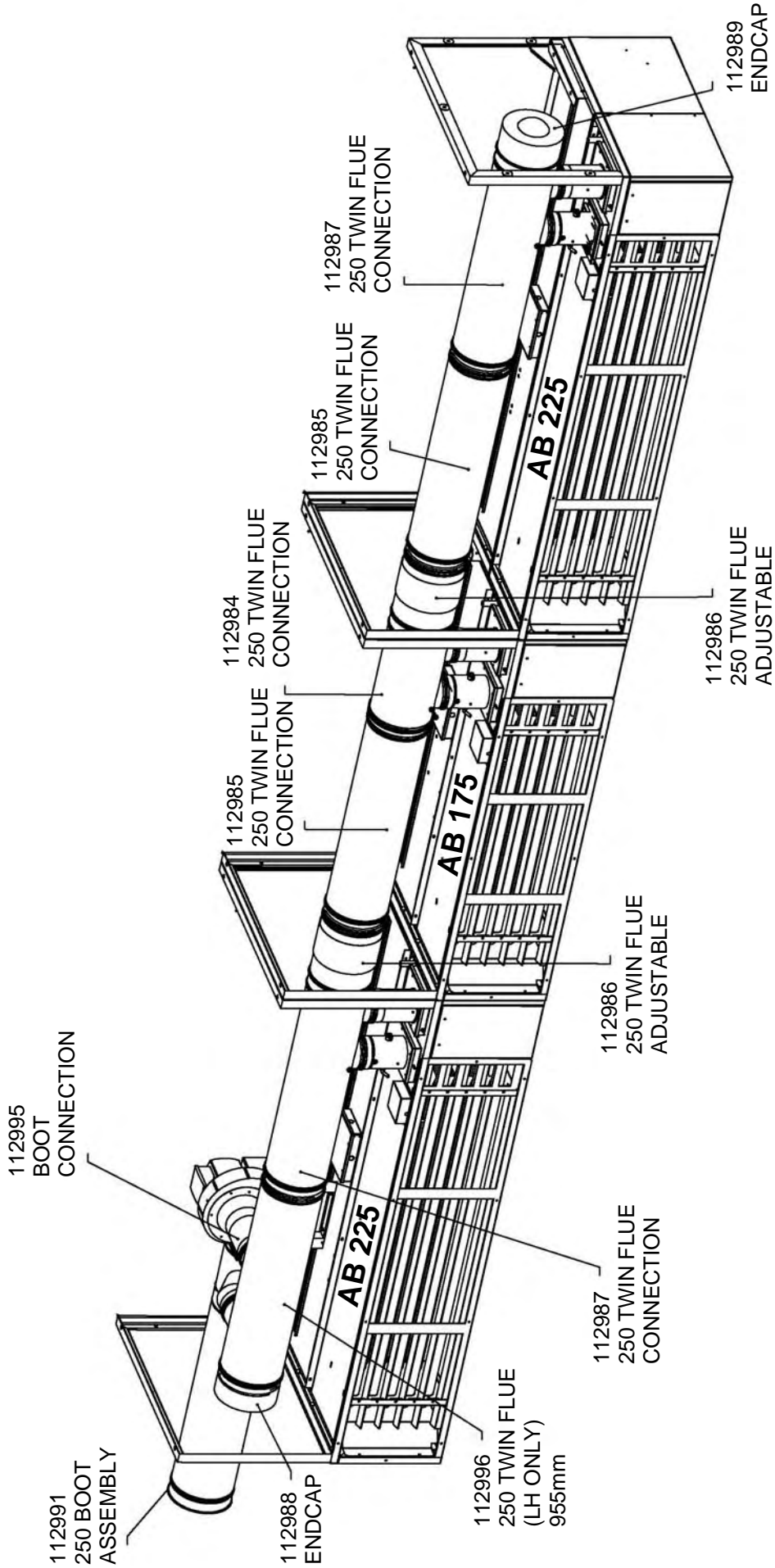

AB 625 RH flue configuration (1 x AB 225 1 x AB 175 1 x AB 225)

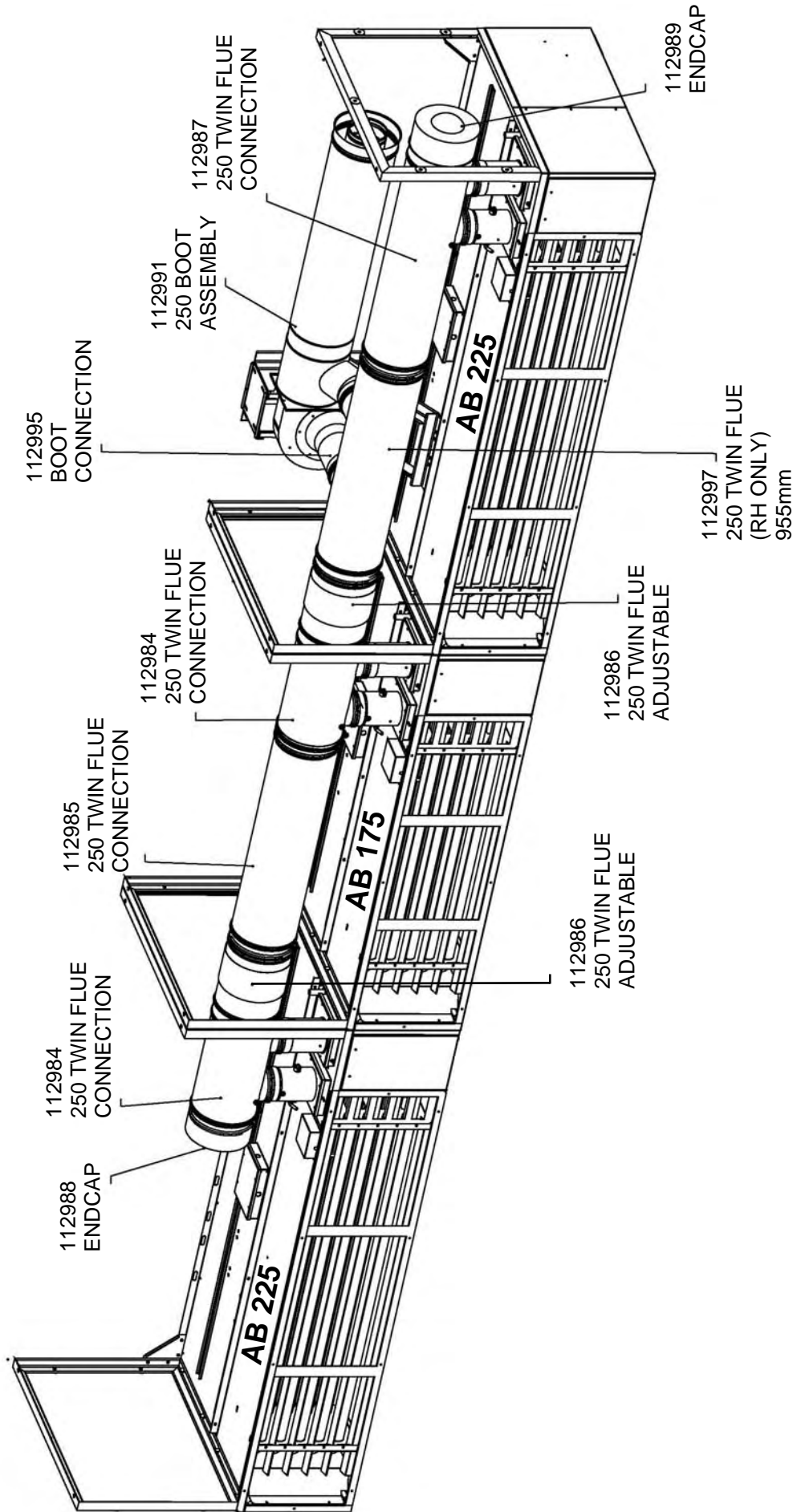

AB 675 LH flue configuration (3 x AB 225)

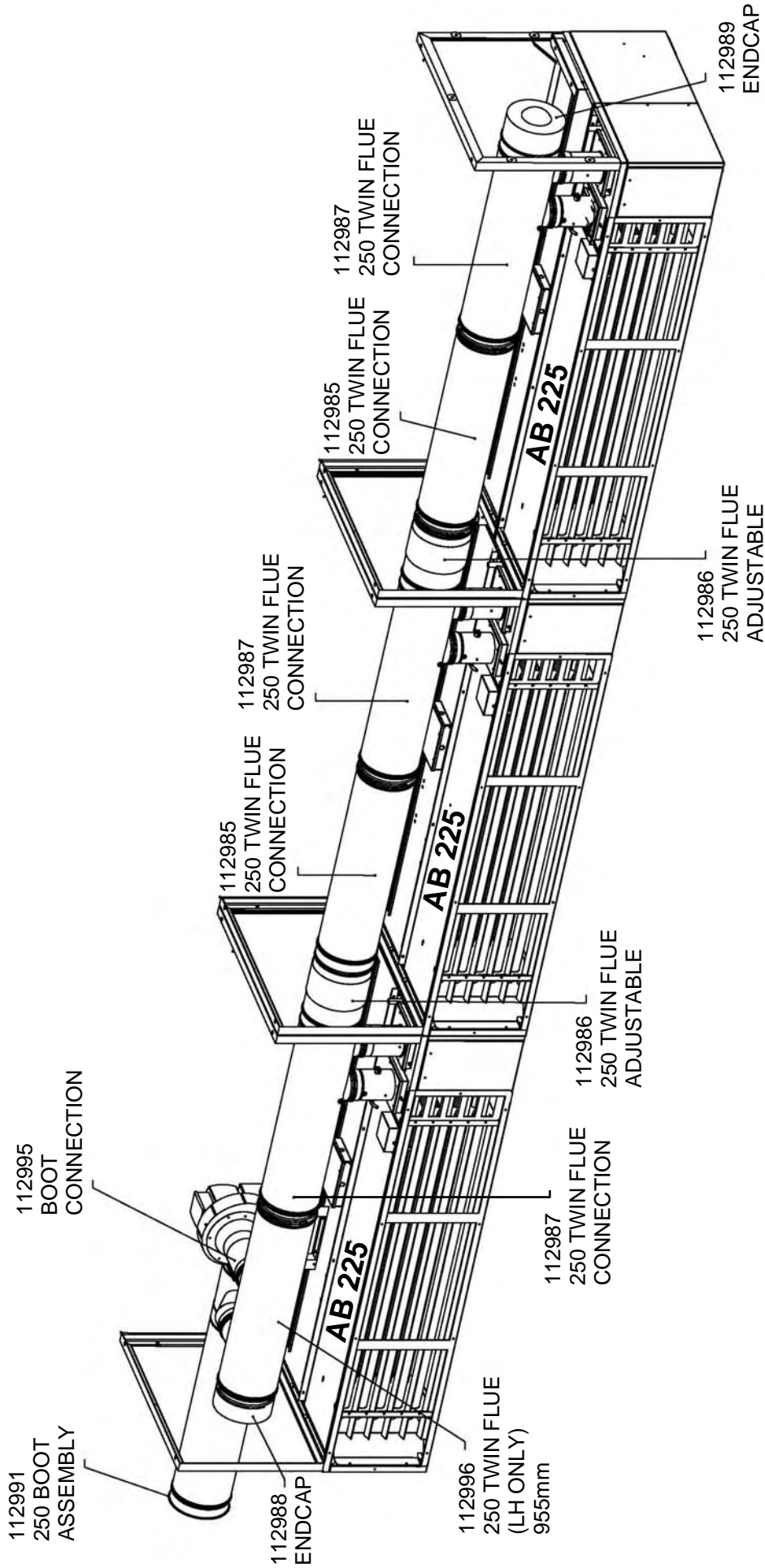

AB 675 RH flue configuration (3 x AB 225)

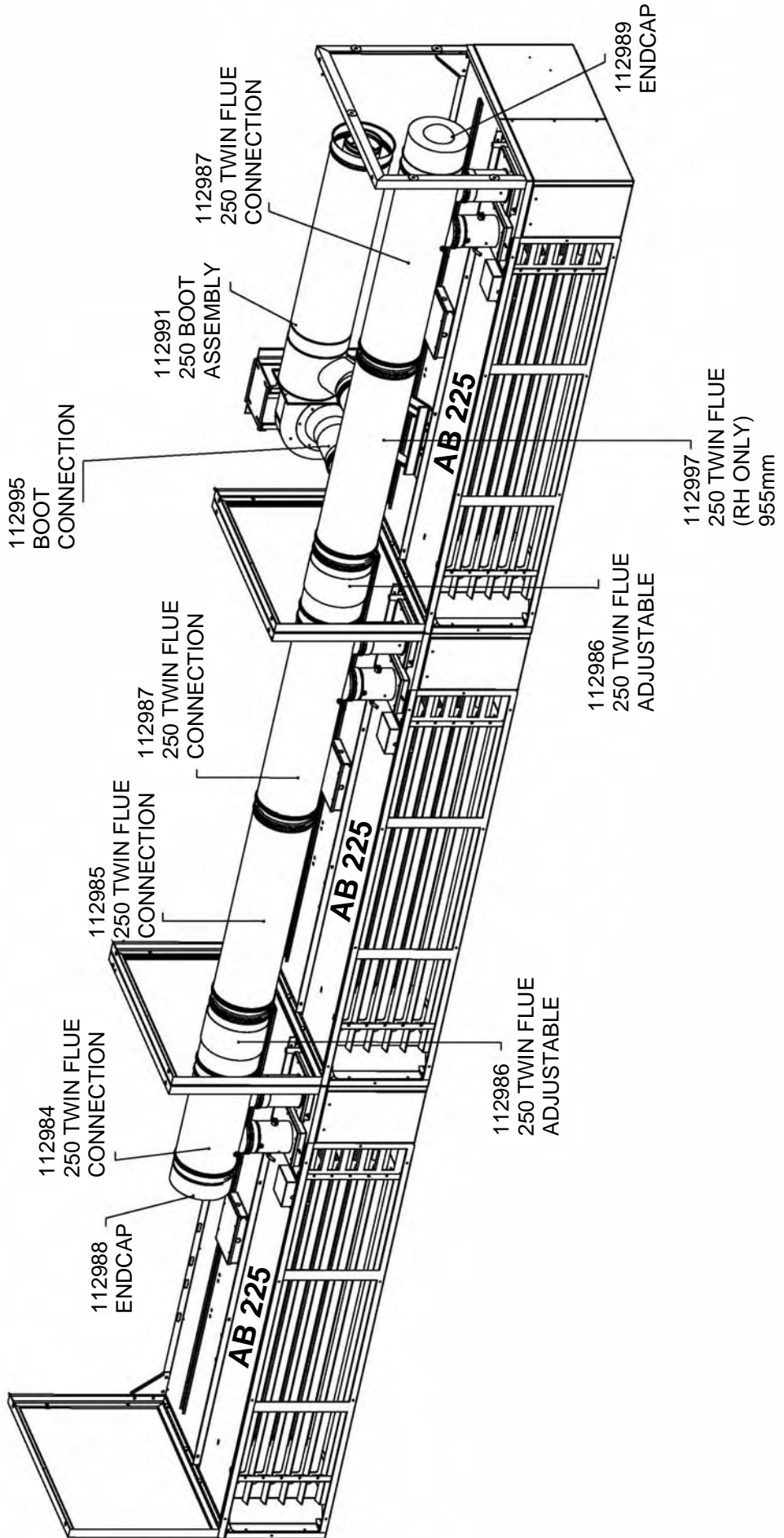

5. Wiring Details.

Diagram 7: Burner control wiring

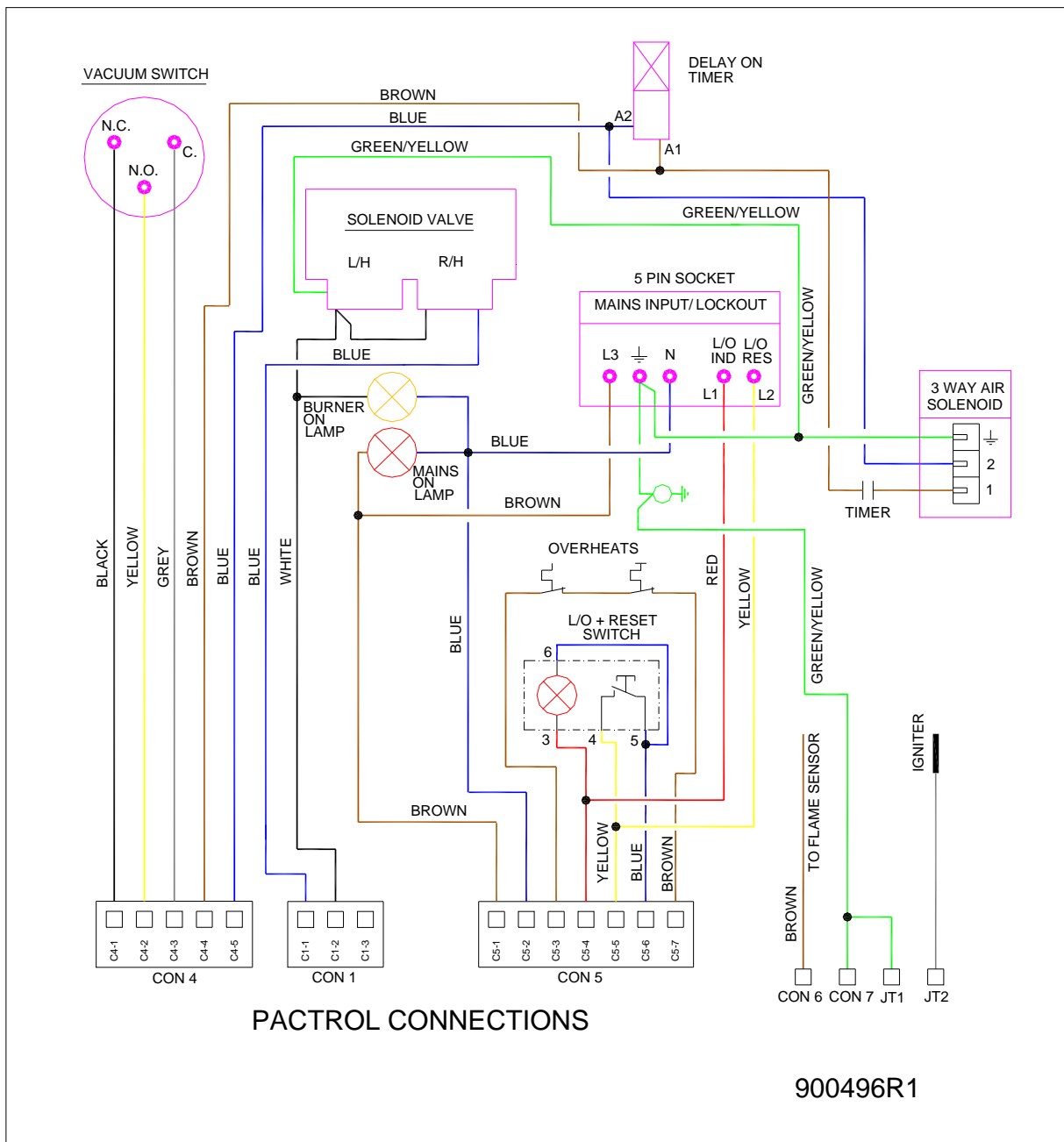

In addition to the above burner wiring diagram, a customer specific control panel wiring diagram will be supplied with each air heater.



WARNING:

THIS HEATER SHOULD NOT BE INSTALLED WHERE THERE IS A CORROSIVE ATMOSPHERE.

5. Wiring Details cont.

5.1 Burner controls

The burner controls are mounted in the burner control cubicle which is an integral part of the air heater casing and are accessible by opening a hinged lid on the right hand side of the air heater (see Figs. 7 and 8 in section 8 of this manual for details). The controls accessible in the cubicle are: gas solenoid valve, ignition controller, air pressure switch, flame probe, ignition electrode, reset switch, timer, 3 way air solenoid, red and amber neon lamps, plus associated wiring harness. For details see burner wiring diagram in section 5, page 8.

5.2 Control panel.

The electrical control panel incorporates the facility to interlock with the door opening mechanism and automatically switch the air heater between high/low speed as the door is opened and closed. A pair of volt free auxiliary contacts are required on the door open/close contactor which should make as the door opens. If this is not available then a suitably positioned limit switch and striker plate will need to be fitted to the door.

The panel incorporates an auto/off/manual selector switch, which, when in 'auto' mode operates the air heater in low speed via an external room thermostat provided the door is the down position. In the door up position the air heater operates in high speed and overrides the room thermostat. The 'manual' position overrides the door interlock and thermostat, and the 'off' position turns the air heater off.

A cool/heat selector switch is also incorporated which allows the air heater to supply heated air, or unheated ambient air.

The panel also contains a removable link on the main terminal rail to allow the air heater to be switched on and off remotely via a BMS control relay.

The panel may also be fitted with optional low voltage (24V AC) relays for fire alarm/door contact interlocks.

Regardless of the position of any of the above switches, the main air fans must be running to allow the burner to run.

5.3 Overheat protection.

In the event of any overheat condition there are two thermal limit controls fitted inside the air heater. The controls are factory set and non-adjustable. The self resetting (cycling) control activates at 70°C, and the manual reset control at 96°C. If either set point is reached, the corresponding limit control will interrupt the electrical power to the burner gas valve. The burner will not relight until the limit control has reset. The manual reset button is located on top of the heater on the left hand side of the thermostat cover and can be accessed after first removing the dust cover. (See Figs. C and D). These safety devices provide protection in the event of an air distribution fan motor failure, or lack of airflow due to restrictions. (For location see section 8 Fig.29, and section 5 diagram 7, burner controls wiring diagram).

Warning: never attempt to bypass the thermal limit controls as hazardous conditions could result.



Fig. C



Fig. D

6. Servicing.

! These appliances should be serviced annually by a competent person to ensure safe and efficient operation. In exceptionally dusty or polluted conditions more frequent servicing may be required. The manufacturer offers a maintenance service. Details available on request. *Isolate gas and electricity supplies before commencing any work.*

6.1 Tools Required.

The following tools and equipment are advisable to complete the tasks laid out in this manual.

! Suitable alternative tools may be used.

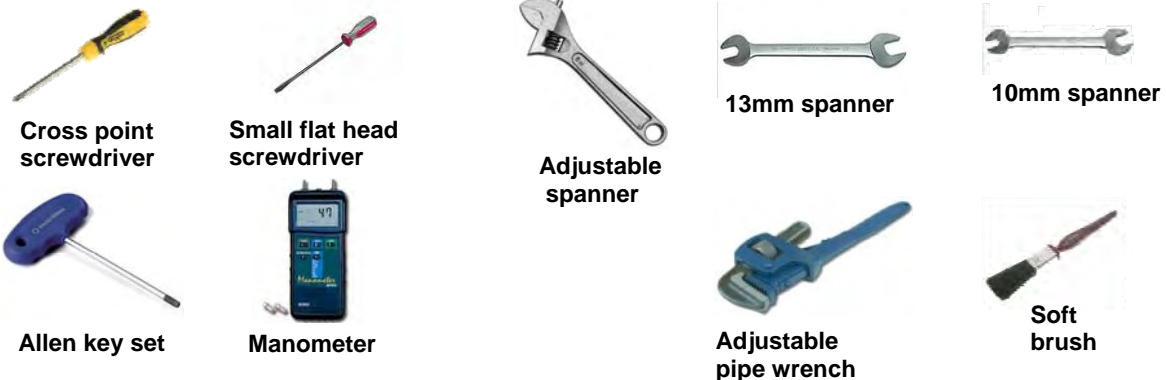

6.2 Burner assembly.

The major components of the burner assembly can be accessed by removing the two lid retaining screws located on the right hand side on top of the air heater, and swinging the lid downwards as shown in Fig 7 in section 8 of this manual. Section 8 also details the removal of the major components.

6.2.1 Manifold/injectors.

Remove the manifold complete with injectors as described in section 8. The manifold/injectors should be examined for signs of debris and cleaned if necessary by blowing compressed air in the reverse direction to flow. Individual injectors can be replaced if necessary.

6.2.2 Burners.

Access to the burners is achieved by first removing the mounting plate carrying the ignition sequence controller and pressure switch, (see section 8). The access plate can now be removed after unscrewing the four fixing screws. The burners can now be examined and cleaned using a soft brush, or by blowing compressed air in the reverse direction to flow. Individual burners can be replaced if necessary by removing the two retaining screws.

6.2.3 Spark electrode .

Remove the spark electrode as described in section 8 and examine. If it is in good order check the electrode gap, this should be $3.5\text{mm} \pm 0.5\text{mm}$. Adjust the gap if necessary by carefully bending the earth rod, then re-checking the measurement.

6.2.4 Flame probe.

Remove the flame probe as described in section 8 and examine for signs of erosion. The probe should be cleaned if necessary using a fine grade emery paper.

6.3 Emitter tubes.

6.3.1 External.

Brush away any dust on the exterior of the emitter tubes after first removing the ten screws retaining the mesh air inlet grille as shown in Fig.0. overleaf

6.3.2 Internal.

To gain access first remove the five retaining screws from the inspection cover as shown in Fig.1 overleaf.

6. Servicing cont.

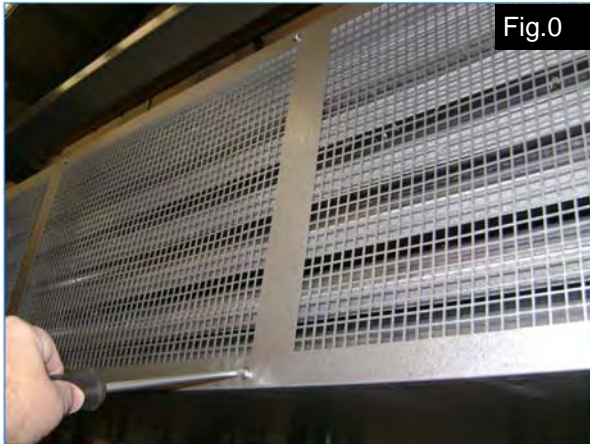

Clean out the emitter tubes using a suitable flue brush/scraper fitted with flexible extension rods.



Remove the six flue box lid retaining nuts from their captive studs as shown in Fig.2. then remove lid taking care not to damage the gasket.

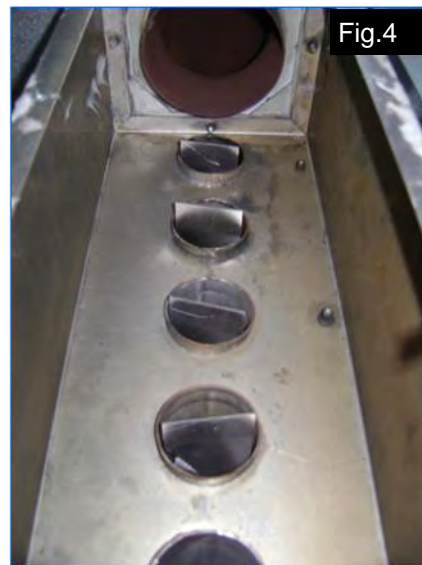

Remove turbulators (5 off) as shown in Fig.3, and clean off any dust or deposits with a soft brush.

! **NOTE:** The turbulators are fitted in the emitter tube non-firing legs only. (See Fig.4)

! **NOTE:** To clean the firing legs of the emitter tubes it is necessary to remove the burners as described in section 6.2.2.

6.4 Air outlet louvres.

The air outlet louvres should be cleaned with a soft brush. Check that the louvres are set to the required angle.

6.5 Air distribution fans.

The air distribution fans can be accessed by opening the fan lid as described in section 8. Clean off any dust or deposits with a soft brush paying particular attention to the impeller. Check that the impeller spins freely, and that there is no play in the fan bearings. The fan(s) can be removed, if necessary, as described in section 8.

! **NOTE:** Following any servicing work it will be necessary to re-commission the air heater (See section 7).

7. Commissioning.

! This appliance must be commissioned by a suitably qualified engineer

7.1 Gas connection

Only persons suitably qualified to work on gas fired appliances may carry out commissioning and testing. The whole of the gas service installation including the meter must be inspected, tested for gas soundness, and purged in accordance with the current rules in force.

! WARNING: Never use a naked flame for checking gas soundness.

7.2 Air heater gas pipework

The gas soundness of the air heater pipework has been checked prior to leaving the factory. However during installation, connections may have been loosened. Check the gas soundness of the appliance pipework using suitable leak detection fluid. If any leaks are found they must be rectified immediately.

7.3 Turning the air heater on

The following checks should be carried out before attempting to light the air heater.

7.3.1

Ensure that the gas supply to the air heater is turned on.

7.3.2

Ensure that the electrical supply to the control panel is switched on. Ensure that the control panel heat/cool selector switch is set to the 'heat' position. The air heater will now start automatically.

! Note: If the air heater will not start on initial start up, the ignition controller may be in lockout position and require resetting. This may occur especially if the appliance has been on stand-by for a prolonged period.

7.4 Air heater lighting sequence

AB air heaters are fitted with automatic spark ignition. When adequate airflow for combustion is proven by an air proving switch, and a pre-purge period has elapsed, the integral igniter and multi-functional gas control operate. The ignition spark ignites the burner and the flame is detected by a flame ionisation rod sensor. If a burner flame is not detected, then the ignition controller proceeds to lockout and will require manually resetting. Lockout is indicated by the illuminated burner rocker switch, and by lockout lamp on the control panel, and can be reset either by pressing the illuminated burner rocker switch or the control panel lockout reset button.

! NOTE: If the first lockout reset is not successful, further investigation will be required to ascertain the fault.

7.5 Burner gas pressure adjustment

The gas pressure is set for the required heat input before the appliance leaves the factory, normally, provided the gas supply to the air heater is in accordance with the supply pressure described on the appliance data plate, the operating pressure will not require adjustment. To check the pressure, the following procedure should be carried out:

7.5.1

Ascertain from section 3 (technical specifications) of this document, and the appliance data plate, the correct operating gas pressure for the air heater burner.

7.5.2

Turn the control panel cool/heat selector switch to the 'cool' position.

7.5.3

Remove the screw from the burner pressure test point of the multi-functional control valve (see Fig. 5).

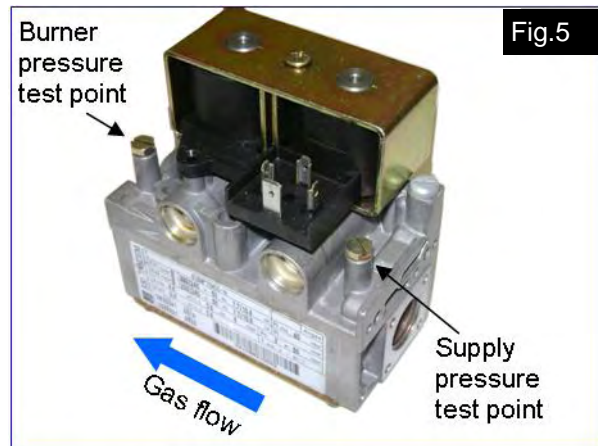

7.5.4

Connect a suitable manometer to the burner pressure test point.

Turn the control panel cool/heat selector switch to the 'heat' position, then wait for burner to light.

7.5.5

Observe the burner gas pressure reading on the manometer and compare to the required pressure.

7.5.6

Adjust if necessary as follows:

First remove the plastic dust cover from the regulator adjusting screw. Turn the regulator adjusting screw anticlockwise to decrease pressure, or clockwise to increase pressure. (See Fig. 6 overleaf) Replace dust cover.

7.5.7

Set control panel heat/cool switch to the cool position to turn OFF the burner. Replace the test point screw (if removed). Relight the burner and test for gas soundness using suitable leak detection fluid.

7. Commissioning cont.

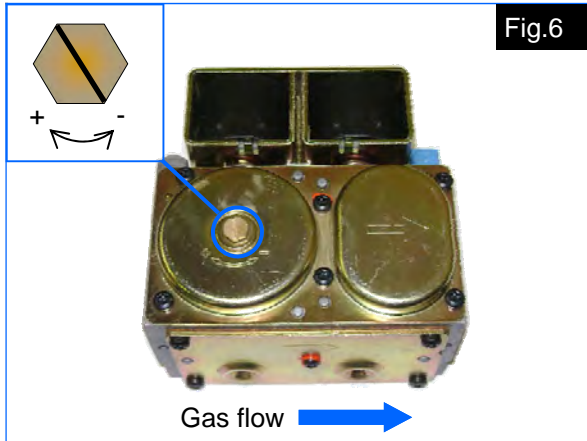

7.6 Flue damper setting.

Each burner pressure switch tube is fitted with a test point tee for connecting to a manometer. See Fig. 6A below.

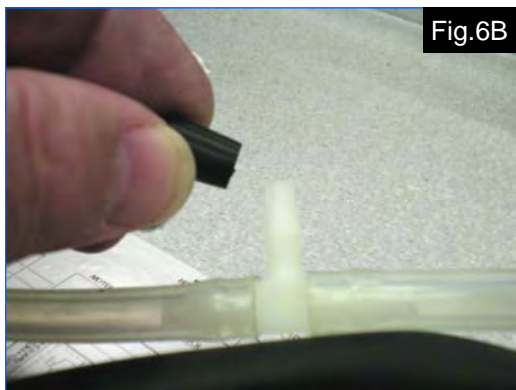
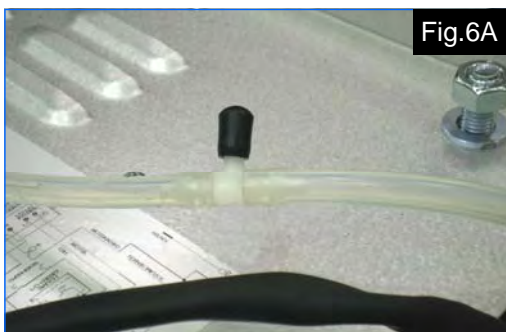

Remove blanking cap as shown in Fig.6B and connect manometer to test point tee. With the burner firing check for the correct vacuum pressure at each burner. The settings must be as follows:

Hot reading: 3.4 millibar

Cold reading: 4.5 millibar

After checking, any adjustments required should be made at the flue damper on each burner as follows:

- Loosen the flue damper handle grub screw.
- Move the handle in the required direction to increase or decrease the vacuum as required.

- Re-check manometer reading.
- Re-tighten flue damper handle grub screw.

7.7 Air solenoid timer setting. (2 module)

Each burner is fitted with an electronic timer to control the operation of the three port air solenoid valve. The timers should be adjusted in pairs using the settings dials as shown in the following pictures:

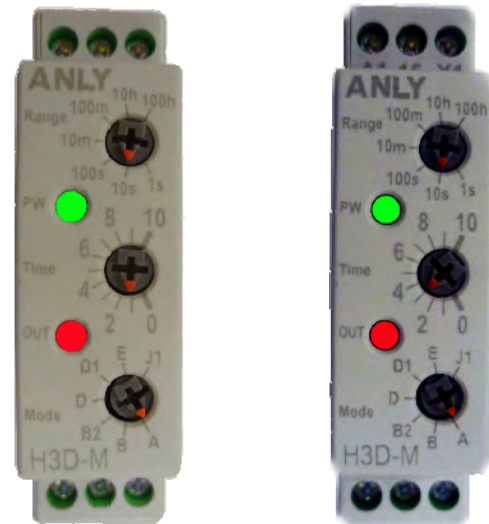

Timer 1: 1 second

Timer 2: 3 seconds



Note: Timer 1 is in the burner housing furthest from the flue fan.

Timer 2 is in the burner housing nearest to the flue fan.

7.8 Air solenoid timer setting. (3 module)

3 module models have 3 timers. Follow the setting procedure detailed above.

The settings are as follows:

Timer 1: 1 second

Timer 2: 3 seconds

Timer 3: 5 seconds



Note: Timer 1 is in the burner housing furthest from the flue fan.

Timer 2 is in the middle burner housing.

Timer 3 is in the burner housing nearest to the flue fan.

8. Parts Replacement.

! *All servicing/maintenance work on this air heater should be carried out by suitably qualified and Gas Safe registered engineer. Before commencing any work please ensure that the gas and electricity supplies are turned off. Always test for gas soundness with a suitable leak detection fluid.*

8.0 Tools required.



Allen key set



Adjustable pipe wrench



Adjustable spanner



Cross point screwdriver



10mm spanner



13mm spanner

8.1 Burner/control assembly.

The major components of the burner/control assembly can be accessed by removing the two lid retaining screws located at the top of the hinged lid, then swinging the lid downwards as shown in Fig 7.

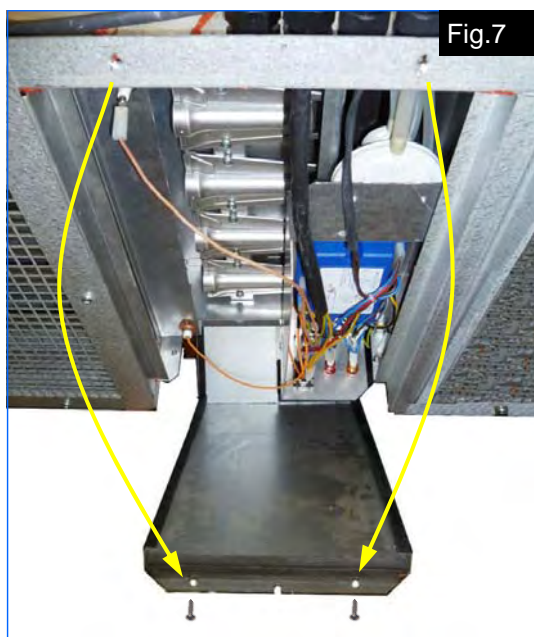

Fig.7

8.1.1 Gas valve.

Remove electrical connectors as shown in Fig.8



Fig.8

Disconnect the mains gas pipe feeding the air heater complete with gas cock. Remove the two strain relief plate screws (arrowed, Fig.9). The pipe can only be removed downwards complete with the gas valve, (see description and Figs. 10 and 11 overleaf).

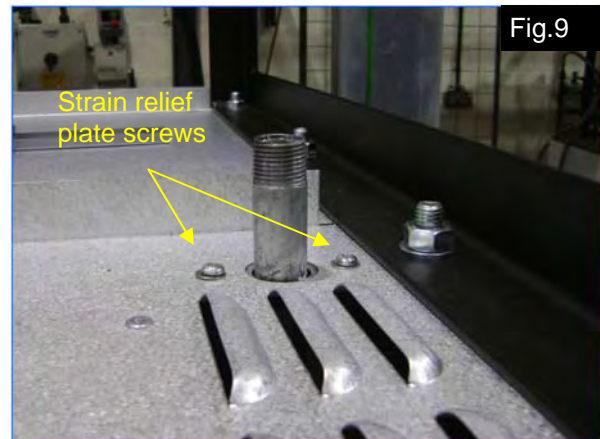

Fig.9

8. Parts Replacement cont.

Using a suitable pair of spanners release the union on the outlet side of the gas valve as shown in Fig. 10.

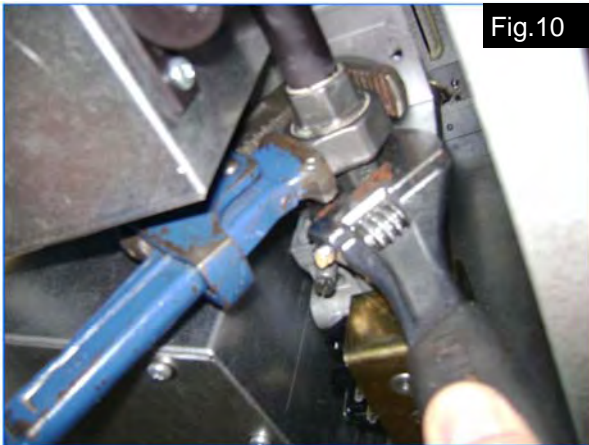

Fig.10

The manifold can now be removed downwards complete with injectors. Fig.13 shows the manifold with injectors in isolation for clarity.

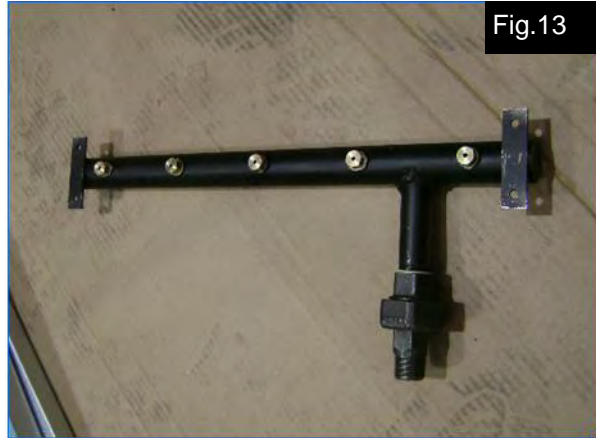

Fig.13

Remove the two mounting bracket screws as shown in Fig.11.

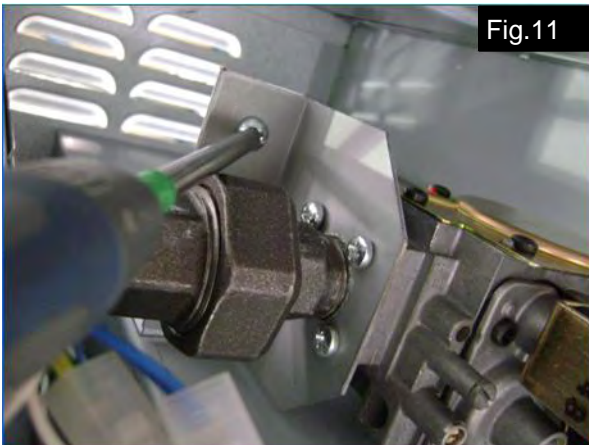

Fig.11

The valve can now be withdrawn from the air heater, and the mounting bracket removed if necessary

8.1.2 Gas manifold/injectors.

Follow previous steps describing removal of valve to manifold pipe union. Remove the four manifold retaining screws as shown in Fig.12.

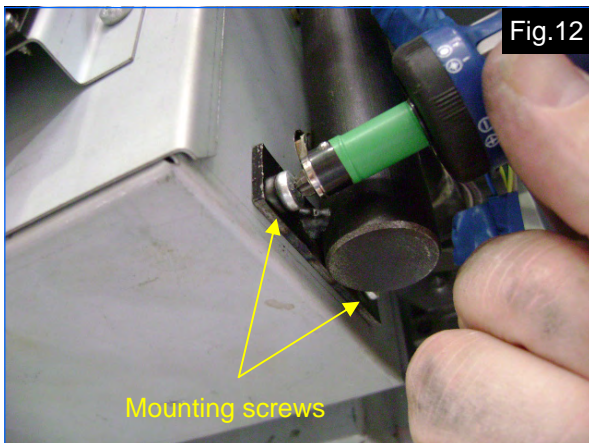

Fig.12

8.1.3 Air pressure switch.

Remove the two silicon tubes from the connection spigots of the air pressure switch as shown, noting their positions. See Fig.14.

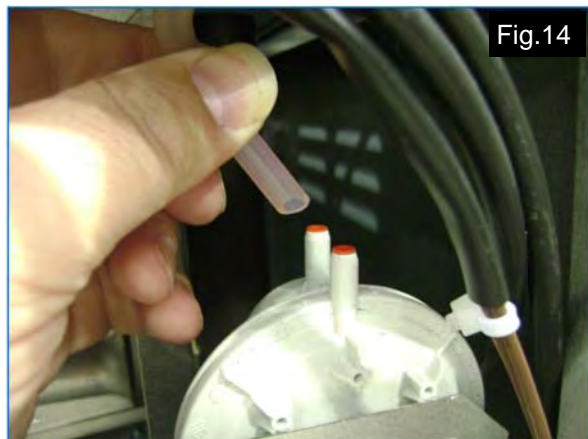

Fig.14

Remove the two retaining screws as shown in Fig.15.

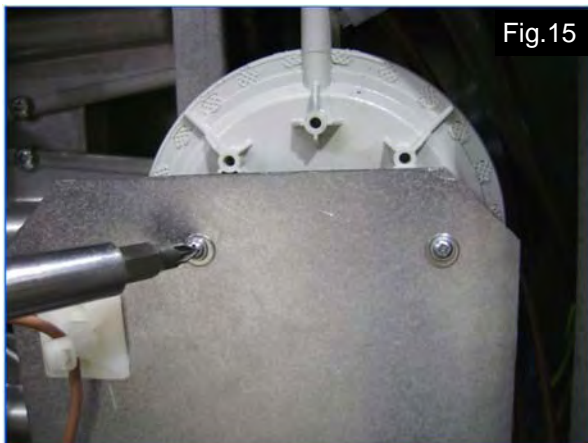

Fig.15

8. Parts Replacement cont.

Lift the air pressure switch upwards from the rear of the mounting plate then remove the three female spade connectors as shown in Fig.16 then remove switch.

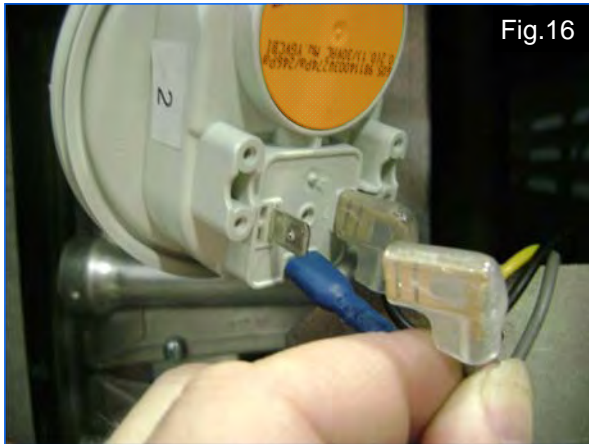

Fig.16

8.1.6 Flame probe.

Remove the flame probe cable spade connector as shown in Fig.19.

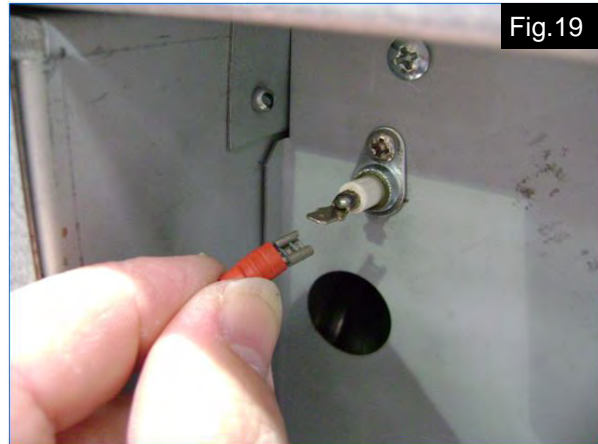

Fig.19

8.1.4 Ignition sequence controller.

Disconnect the multi-pin connectors from the ignition controller as shown in Fig.17.

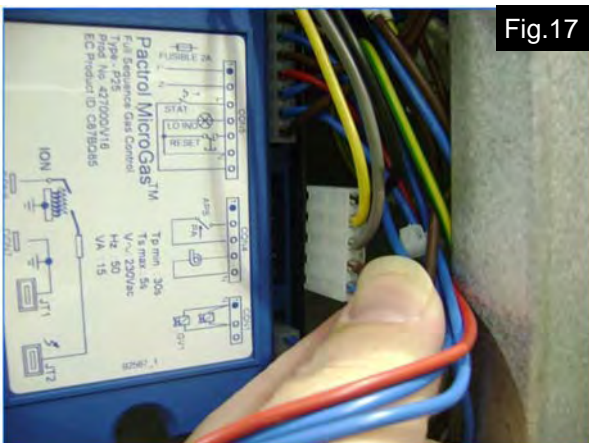

Fig.17

Remove flame probe fixing screw as shown in Fig.20.



Fig.20

Remove the two fixing screws securing the ignition controller to the mounting plate as shown in Fig. 18. then remove controller.

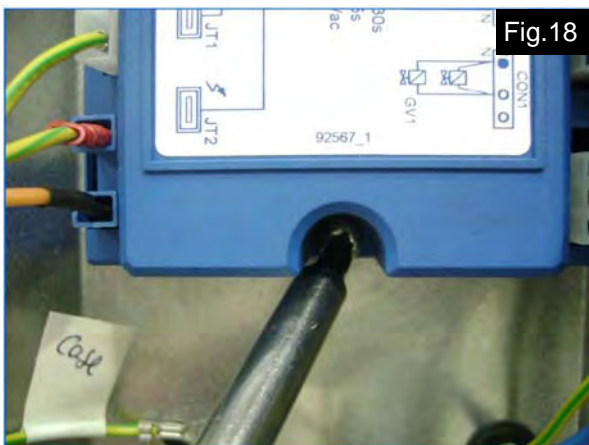

Fig.18

Withdraw flame probe as shown in Fig.21.

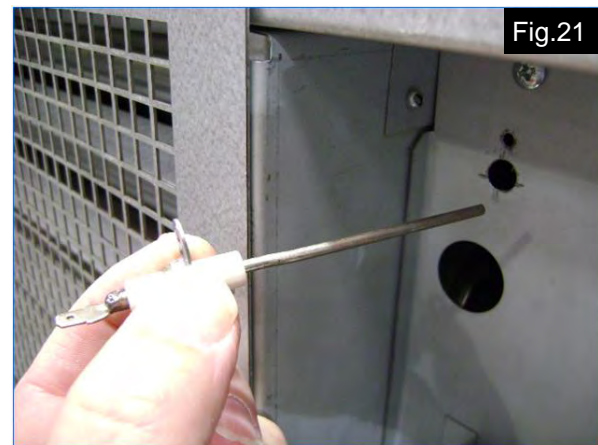
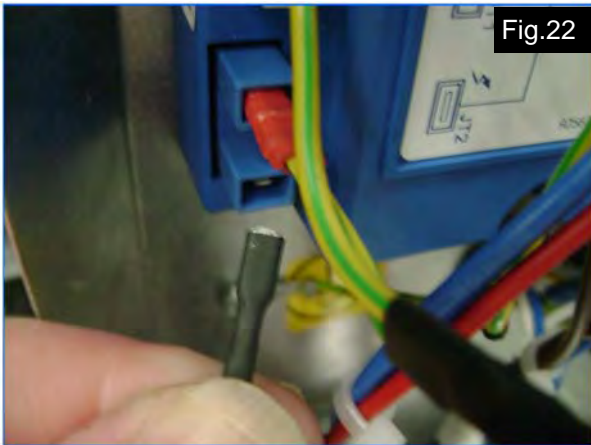

Fig.21

8. Parts Replacement cont.

8.1.7 Spark electrode

Remove the HT cable spade connector from the ignition sequence controller as shown in Fig.22.



Remove fixing screw as shown in Fig.23.



Withdraw spark electrode complete with HT cable as shown in Fig.24.

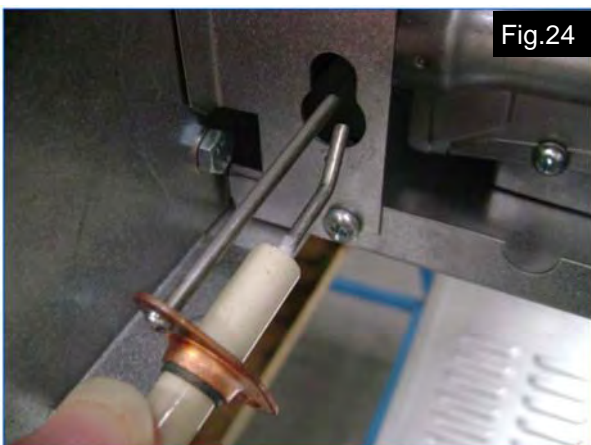

8.1.8 Overheat thermostats

Remove the two retaining screws securing the thermostat access lid as shown in Fig.25.

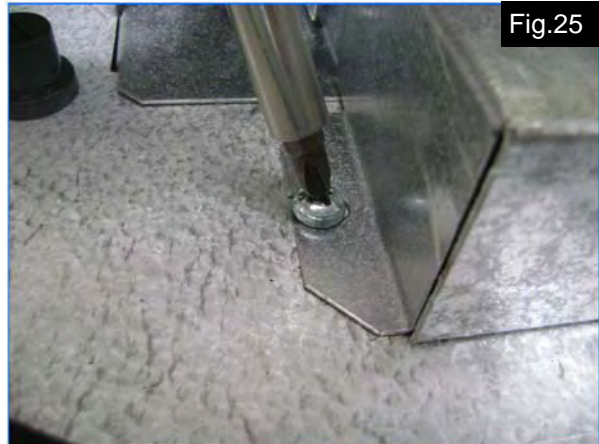

Disconnect the spade terminals from the self resetting thermostat as shown in Fig.26.

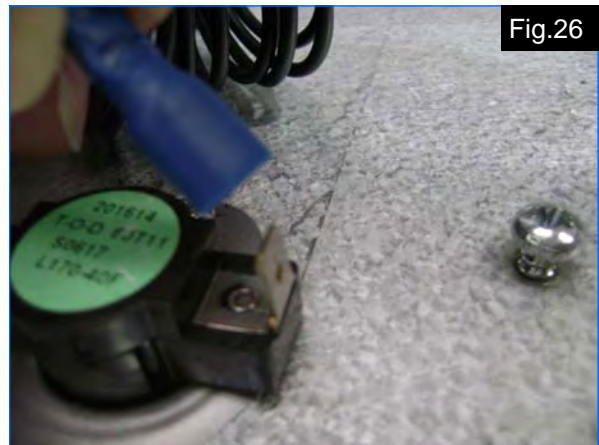

Remove the two retaining screws as shown as shown in Fig.27. and remove.



8. Parts Replacement cont.

Remove the spade terminals from the manual reset thermostat as shown in Fig. 28.



Remove the single retaining screw securing the manual reset thermostat as shown in Fig.29.

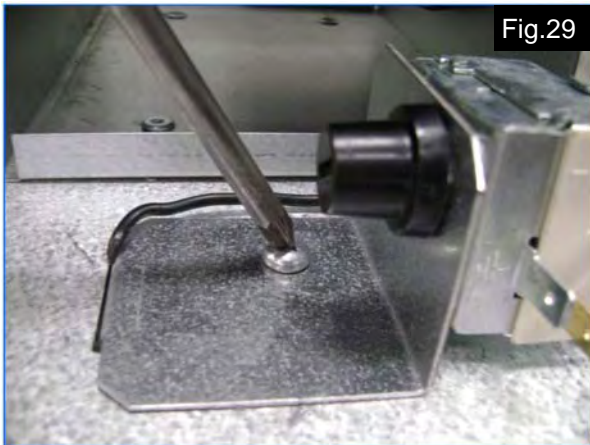

Remove from location slot complete with bracket as shown in Fig.30.



8.2 Air distribution fans.

The air distribution fans can be accessed by removing the retaining screws securing the hinged lid on the underside of the air heater. See Fig.31

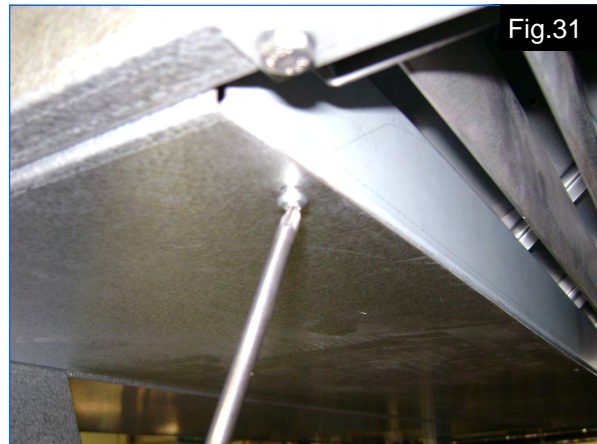

The lid can now be hinged down to access the fans as shown in Fig.32.



8.2.1 Fan closure plate

Before individual fans can be removed it will be necessary to remove the fan closure plate. Remove the retaining screws around the perimeter of the plate. (See Figs.33/34) The plate can now be removed.

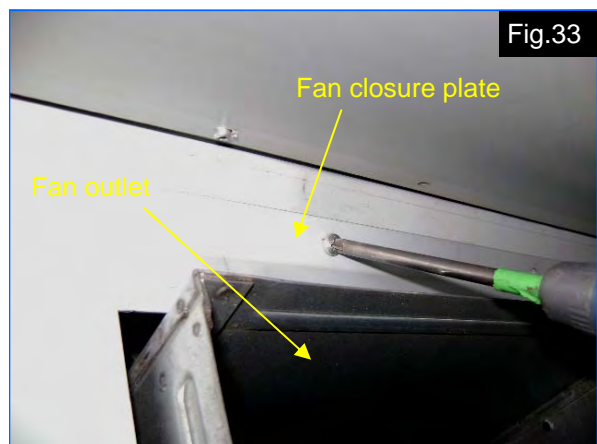

8. Parts Replacement cont.

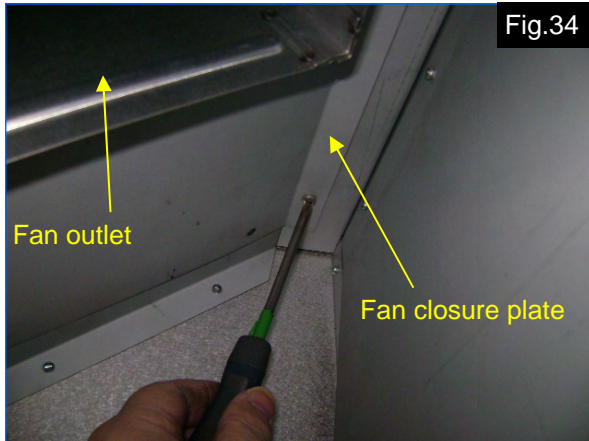
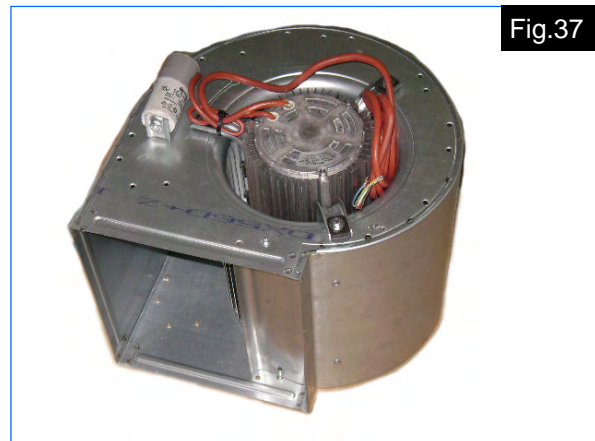
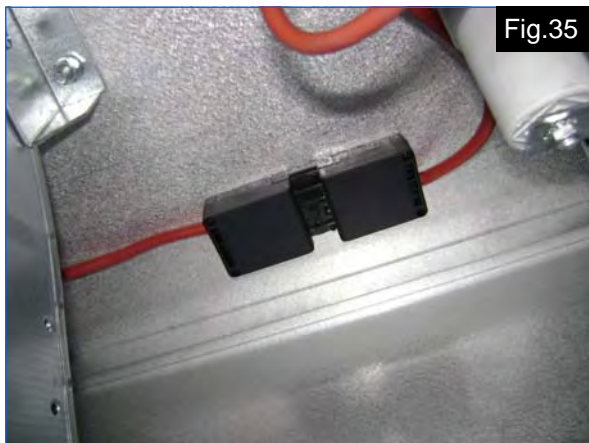

Fig.37 shows single air distribution fan in isolation for clarity.



8.2.2 Fan removal

Identify the feed cable for the fan requiring removal and disconnect it from its cable mounted plug/socket. (See Fig.35)



The four bolts securing the fan can now be removed as shown in Fig.36, and the fan removed from the air heater downwards.

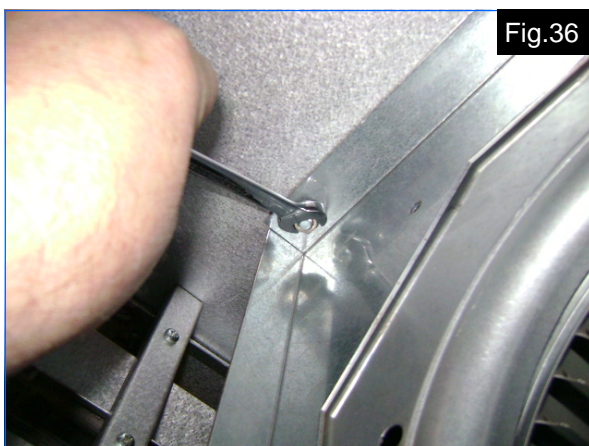

! CAUTION: Handle with care, these fan units are heavy.

9. Spare Parts.

Recommended spares

In order to aid troubleshooting and servicing we recommend that the components shown in this section should be stocked.

! Note: Any spare parts or components used that are not approved by AmbiRad could invalidate the approval of the appliance and also the warranty.

Item	Description	Part No.	Item	Description	Part No.
	Ignition controller	106963		3 speed air distribution fan unit	AB-FAN
	Gas valve twin sol 220/240V ac	2055		Injectors (5 off)	Natural gas: AB 175N/AB 225N 106962/106810 Propane: AB 175P/AB 225P 106958/106957
	Pressure switch	L104039		Manifold	103201
	Combustion (I/D) fan	2590-1		Burner	106715
	Illuminated reset rocker switch	2645		Red neon	2180
	Self resetting limit control	SCLC1		Amber neon	2175
	Flame probe	106798		Manual reset limit control c/w capillary	STLC3
	Flame probe lead	900387		Ignition electrode c/w HT lead	106797
	3 port solenoid valve timer	28-15-027		3 port solenoid valve	2197

10. Fault Finding.

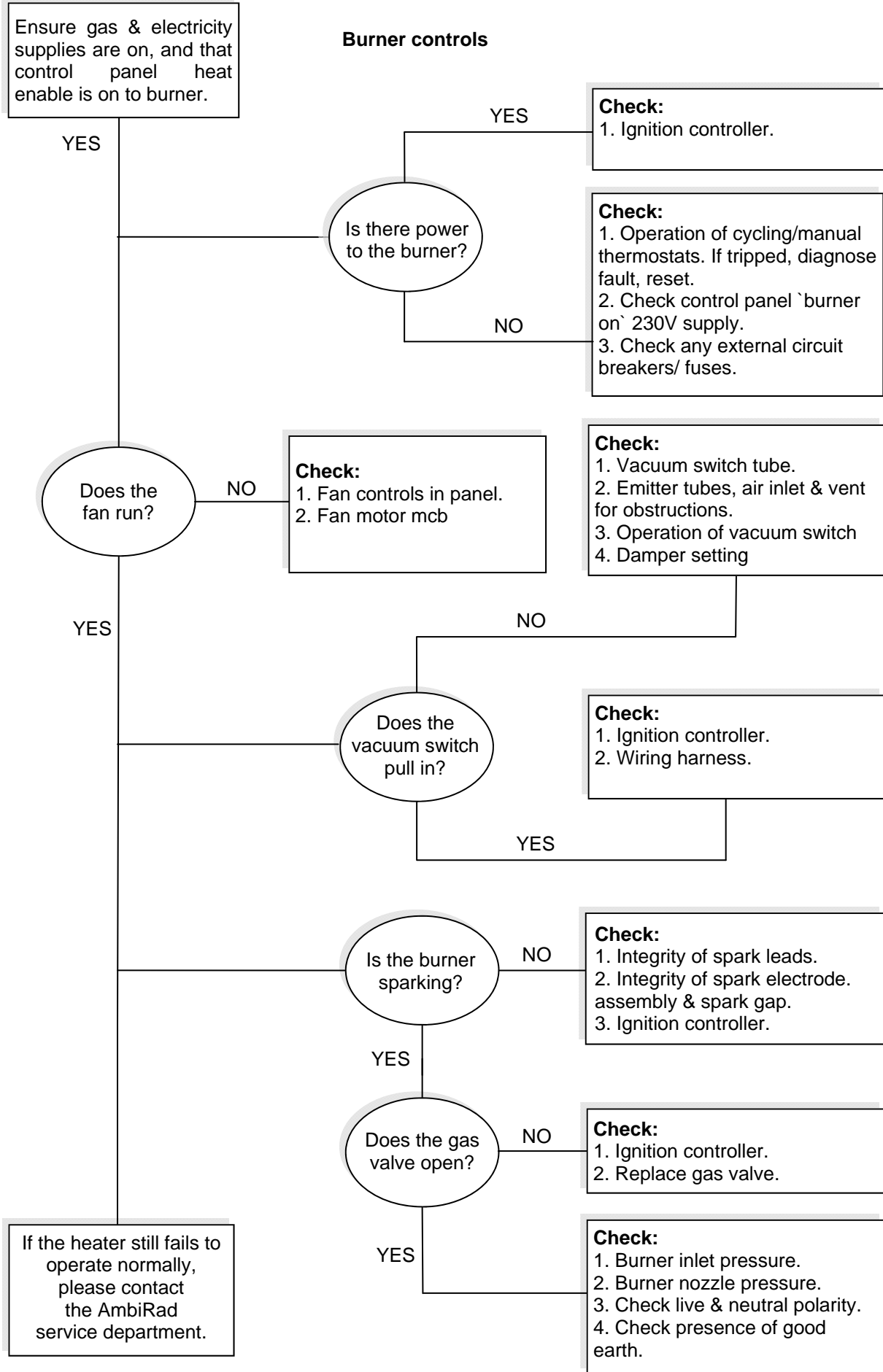

10. Fault Finding cont.

Air distribution fans

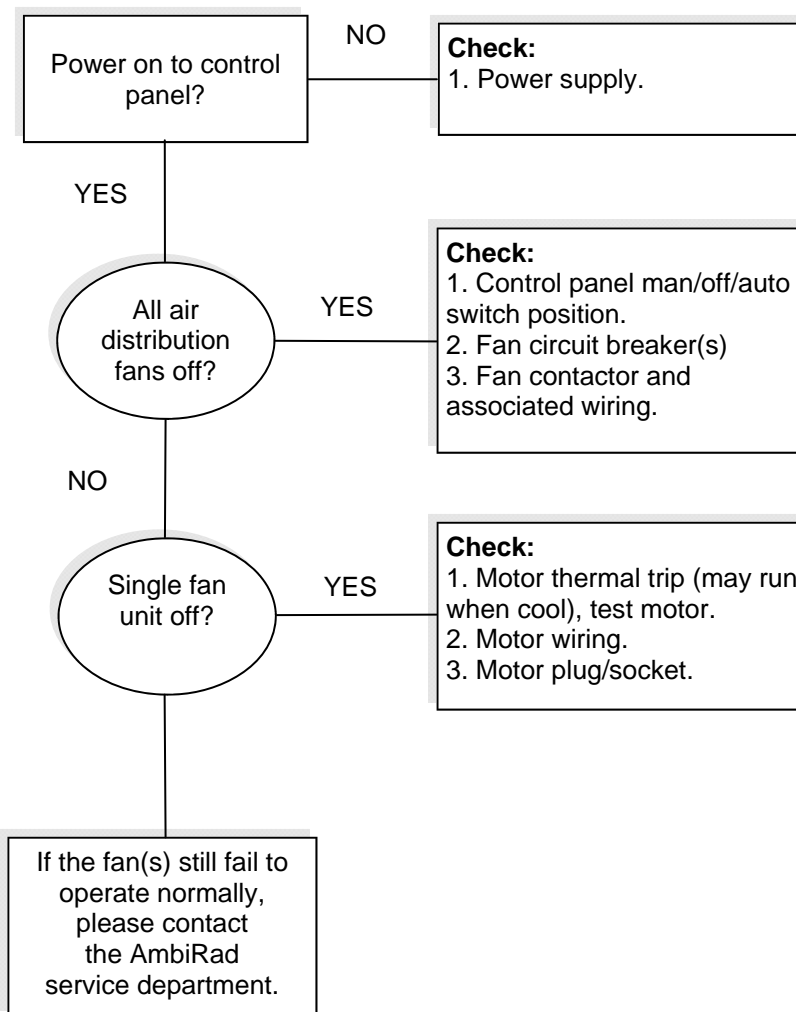

Notes.

Notes.

Notes.

11. User Instructions.

11.1 Important information

This appliance must only be installed by a competent person in accordance with the requirements of the codes of practice and the rules in force in the country of use.

11.1.1 The appliance **must** be earthed.

11.1.2 Never rest anything, especially ladders, against the air heater.

11.2 To start the AB air heater

11.2.1 First ensure that the gas supply to the air heater is turned on.

11.2.2 Ensure that the control panel auto/off/manual selector switch is in the manual position, and that the heat/cool selector switch is in the heat position.

11.2.3 Switch on electrical supply to the control panel. The panel live lamp, and the red burner live neon lamp(s) on the air heater will illuminate, the combustion fan(s) and the air distribution fans will start, and the automatic ignition sequence will commence.

11.2.4 After completion of an air purge period, ignition of the burner will occur, and the amber burner on lamp(s) will illuminate.

11.2.5 If lockout should occur, the red rocker switch on the burner panel, and the lockout lamp on the control panel will illuminate. The lockout

can be reset by pressing the illuminated rocker switch on the burner panel, or the control panel lockout reset button, providing the lockout condition has cleared. If lockout re-occurs, switch off air heater and call out a service engineer.

11.3 To switch off the AB air heater

11.3.1 Rotate the auto/off/manual control panel switch to the 'off' position. The burner will shut off, and the combustion fan(s) and air distribution fans will stop.

11.3.2 If the air heater is switched off for periods in excess of one week, it is highly recommended that both gas and electrical supplies to the air heater are turned off.

11.4 Servicing

To ensure continued efficient and safe operation it is recommended that the air heater is serviced regularly by a competent person, once a year in normal working conditions, but in exceptionally dusty or polluted conditions more frequent servicing may be required.

The manufacturer, (AmbiRad, address given below), offers a maintenance service, details of which are available on request.

For sales related queries please contact the Nordair Niche address given below.



WARNING:

THIS AIR CURTAIN SHOULD NOT BE INSTALLED WHERE THERE IS A CORROSIVE ATMOSPHERE.



NORTEK GLOBAL HVAC (UK) LTD
Fens Pool Avenue
Brierley Hill
West Midlands DY5 1QA
United Kingdom

Tel: 01384 489 250
Fax: 01384 489 707

airbloccsales@nortek.com
www.ambirad.uk

Document reference number GB/AIR/063/0716
Replaces GB/AIR/063/1214