

AIRBLOC AB RANGE

AMBIENT AIR CURTAIN

INSTALLATION AND OPERATING MANUAL

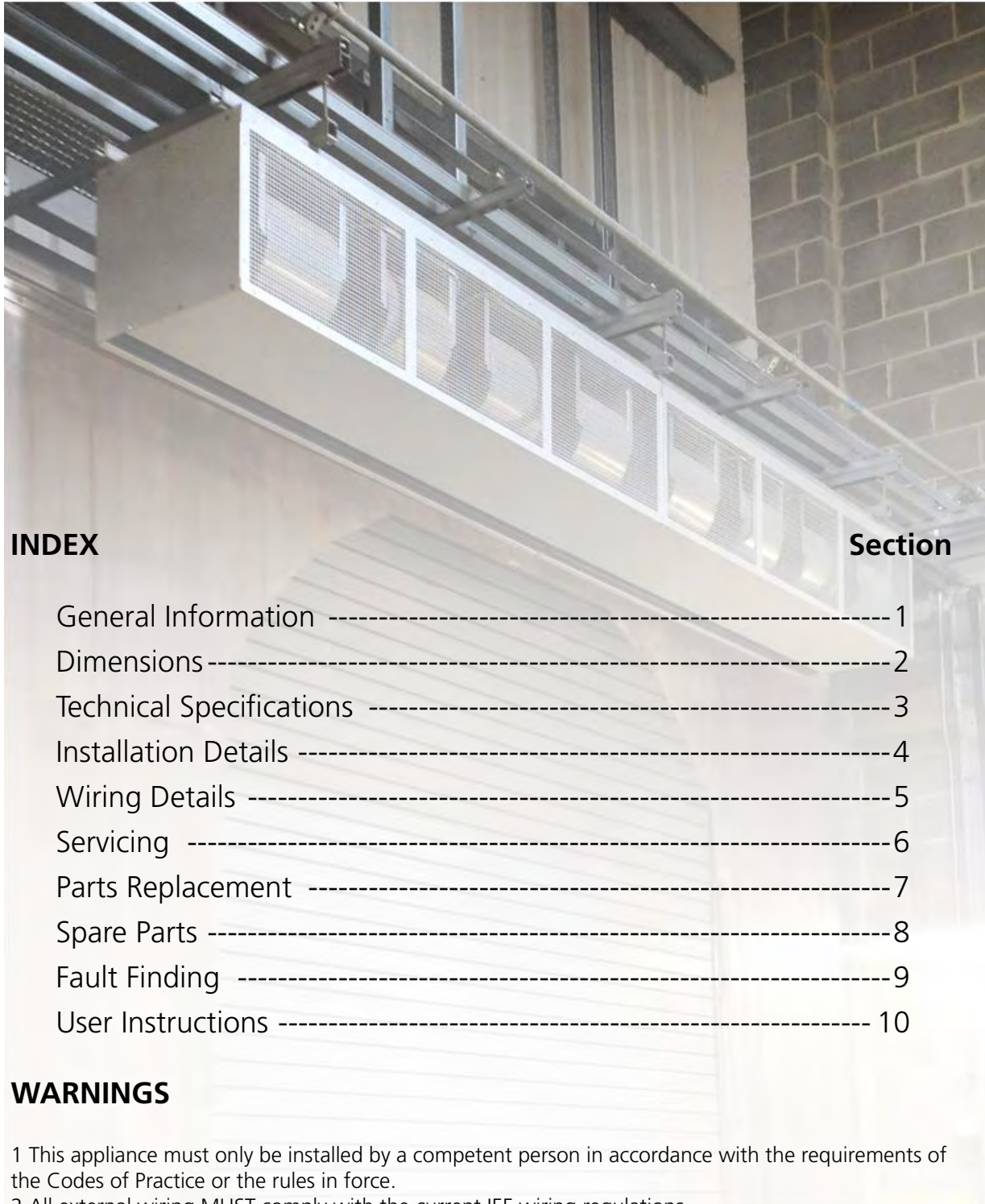

INDEX

Section

General Information -----	1
Dimensions -----	2
Technical Specifications -----	3
Installation Details -----	4
Wiring Details -----	5
Servicing -----	6
Parts Replacement -----	7
Spare Parts -----	8
Fault Finding -----	9
User Instructions -----	10

WARNINGS

- 1 This appliance must only be installed by a competent person in accordance with the requirements of the Codes of Practice or the rules in force.
- 2 All external wiring MUST comply with the current IEE wiring regulations.
- 3 Warning this appliance must be earthed.

Part No. 702100



1. General Information.

Welcome to the new Airbloc AB ambient air curtain models. Local regulations may vary in the country of use and it is the installers responsibility to ensure that such regulations are satisfied.

All installation, assembly, commissioning and service procedures must be carried out by suitably qualified competent persons to the statutory regulations in the country of use.

When assembling, installing, commissioning and servicing is undertaken on the air curtains is required to ensure that working at height regulations are adhered to at the mounting heights specified.

All dimensions shown are in mm unless otherwise stated.

The manufacturer reserves the right to alter specifications without prior notice.

! *PLEASE READ this document prior to installation to familiarise yourself with the components and tools you require at the various stages.*

The primary reason for installing an air curtain is

to prevent the influx of cold outside air through a door opening into a heated area. Typical applications include large despatch bay doors in factories and warehouses, and internal doors between areas of different temperatures. Wider door openings can be accommodated by bolting two or more units together.

Air curtains control the internal climate by emitting an air stream with enough velocity to meet the floor so creating an air barrier in the door area. To prevent the ingress of outside draughts, the discharge louvre is angled outwards, so that the air leaving the building meets the wind trying to enter, thus deflecting it. (See diagrams below).

Airbloc air curtains provide uniform air distribution across the full width of the door, keeping heated or conditioned air inside the building and stopping the ingress of cold air, draughts, and dust.

This manual provides detailed information on the installation of Airbloc air curtains. It is essential that these products are installed in accordance with these manufacturers instructions.



Without air curtain

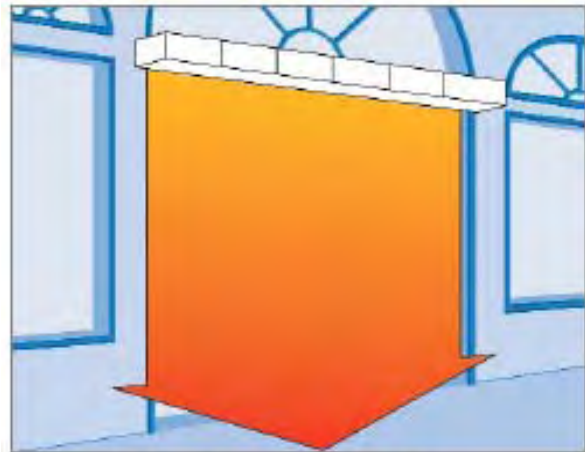

With air curtain

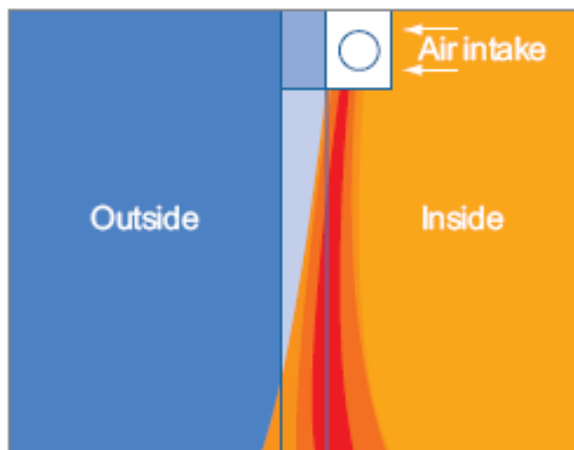

Pattern of airflow

2. Dimensions.

Diagram 1: Dimensions

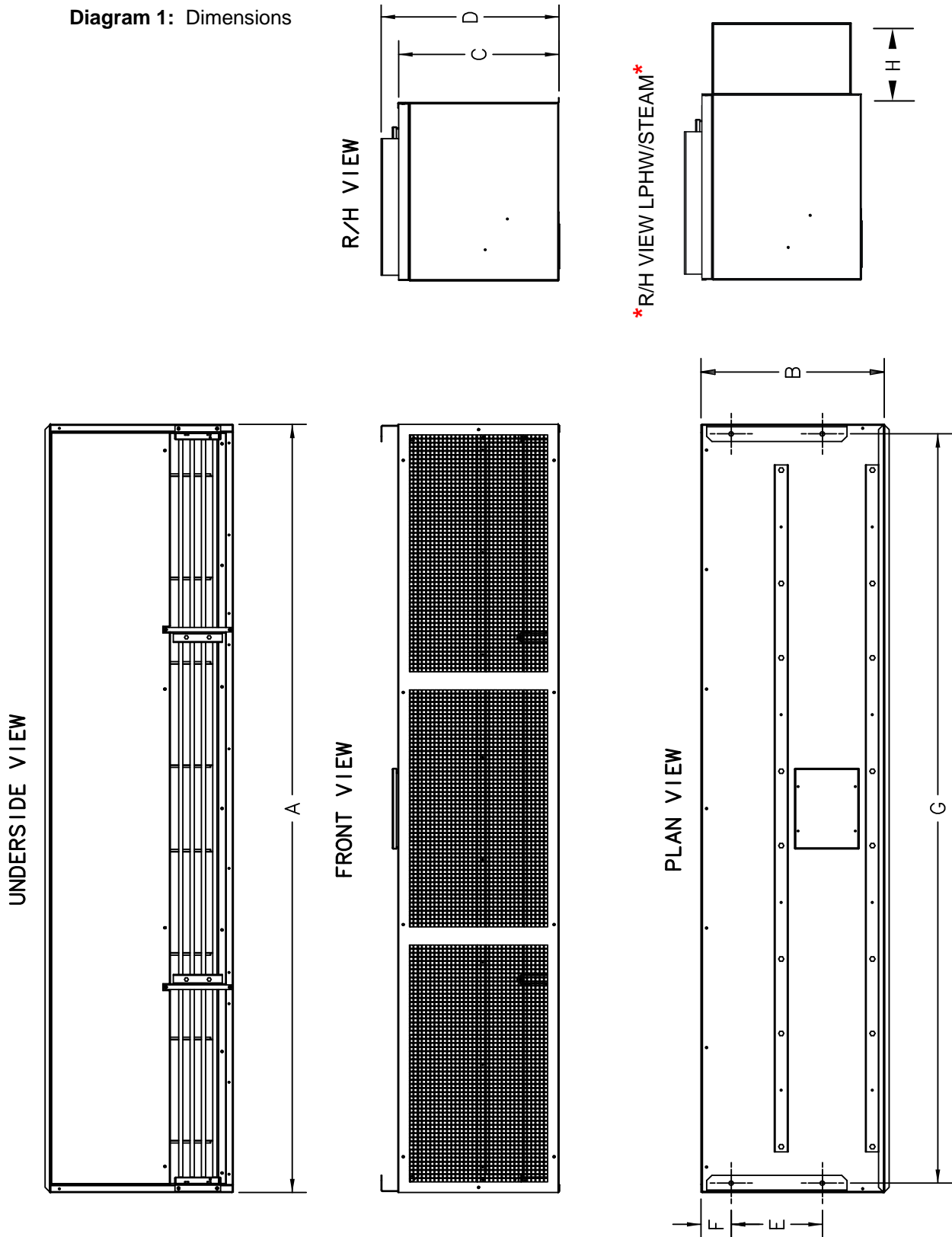

Model	A mm	B mm	C mm	D mm	E mm	F mm	G mm	H mm	Weight (kg)
AB 150A	1500	523	457	507	260	86	1345	201	80
AB 175A	1750	523	457	507	260	86	1695	201	90
AB 225A	2250	523	457	507	260	86	2195	201	115

*Typical projection for LPHW/steam housing (dimension H) LPHW/steam coils available to order. See contact details on rear cover of this document.

3. Technical Specifications.

	Air curtain model		
	AB 150A	AB 175A	AB 225A
Air distribution fans			
Type	Centrifugal (with integral thermal trip)		
Speeds	3		
No. of fans	2	3	4
Maximum air volume	6400m ³ /hr	9600m ³ /hr	12800m ³ /hr
Voltage	230V 1PH 50Hz		
Power rating (per fan)	1140 W		
Current (per fan)	5.2A (FLC)		
Start current (per fan)	12A		
Power			
Total electrical power consumption	2.28kW	3.42kW	4.56kW

Constitution*

Model	AB150	AB175	AB225
AB150=	x 1		
AB225=			x 1
AB300=	x 2		
AB350=		x 2	
AB400=		x 1	x 1
AB450=			x 2
AB525=		x 3	
AB575=		x 2	x 1
AB625=		x 1	x 2
AB675=			x 3

* table shows **full** range of models available and the modules that make up their construction. No other variants are available.



WARNING:
THIS AIR CURTAIN SHOULD NOT BE
INSTALLED WHERE THERE IS A
CORROSIVE ATMOSPHERE.

4. Installation Details.

Health and Safety

Due account should be taken of any obligations arising from the Health and Safety at Work Act 1974 or relevant codes of practice. In addition the installation must be carried out in accordance with the current IEE wiring regulations and any other relevant British Standards and Codes of Practice by a qualified installer. Isolate all electrical supplies to the heater & control panel before proceeding.

For your own safety we recommend the use of personal protective equipment when handling this air curtain.

Airbloc air curtains are supplied with mounting brackets pre-fitted, and can be mounted either as single units, or in multiples, which can be bolted together to suit various door widths.

The minimum mounting height is 3 metres (See diagram 2 below).

4.1

Each single air curtain should be supported by cantilever brackets (not supplied) then fixed back to the building structure by bolting directly using suitable support brackets, or by suspending from above using suitable steelwork. (See diagram 3, page 6).

4.3 Mounting.

Diagram 2.

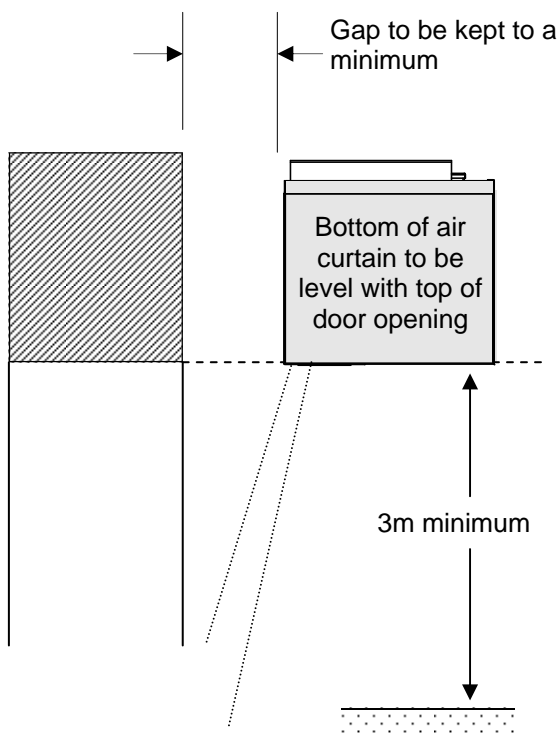

4.2

Multiple air curtains should be bolted together using 3 off M10 set pins, nuts and washers fitted through the holes provided in the mounting brackets, then suitable support channels (not supplied) must be fixed on top of the factory fitted brackets along the full length of the assembled air curtains to spread the load.

The assembly can now be fixed back to the building structure by bolting directly using suitable support brackets, or suspending from above using steelwork. (See diagram 4 page 6).

If required, the support channel may be extended slightly past the ends of the air curtains to aid fixing.

! Note: Where multiple air curtains are fitted above up and over doors or where central support is inappropriate, the support channel should be replaced with channels of a greater cross section to prevent the assembly from bending.

It may be necessary to adjust the position of the air outlet louvres to provide the correct airflow across the door opening. This can be done by first loosening the four locking pins located two at each end of the louvres (arrowed, Fig. A), then loosening the intermediate locking Allen pins (arrowed, Fig. B). The louvres can now be moved to the desired position and the locking pins re-tightened.

! Note: The AB 225 model has two pairs of intermediate locking Allen pins, whereas the AB 175 model only has one pair.

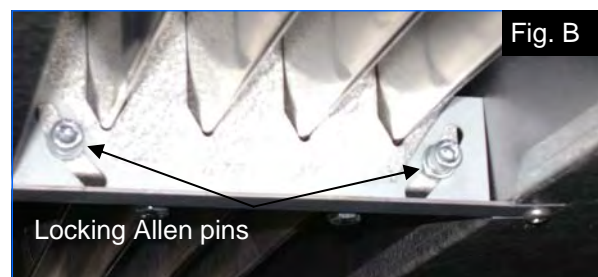
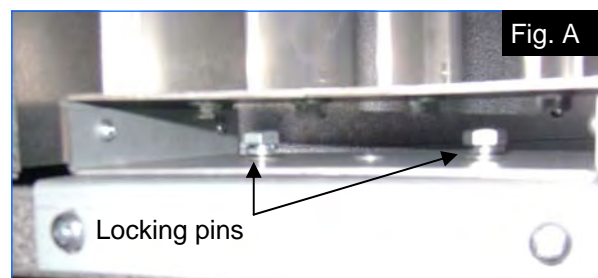

4. Installation Details cont.

Diagram 3: Mounting method (single air curtain)

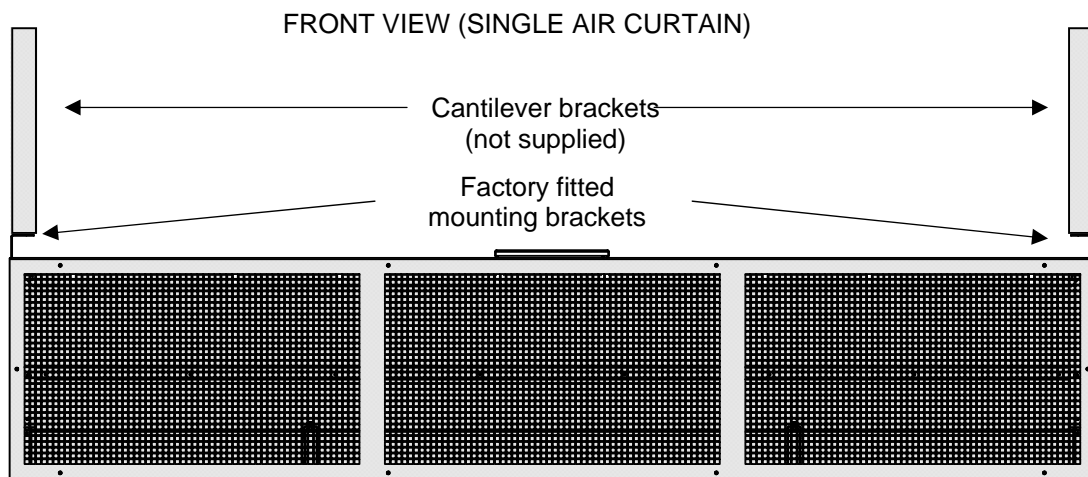
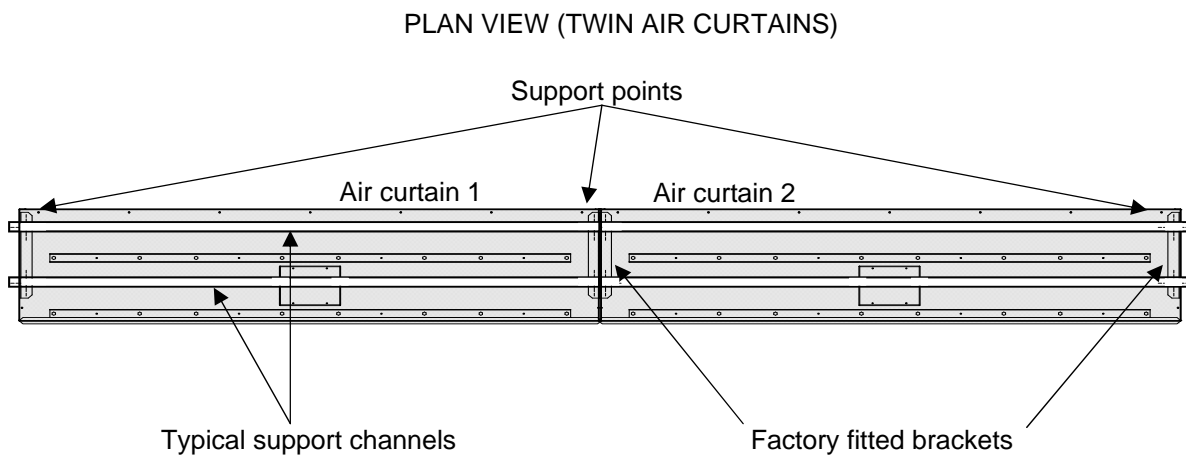

Diagram 4: Support channel (multiple air curtains)



WARNING:

THIS AIR CURTAIN SHOULD NOT BE INSTALLED WHERE THERE IS A CORROSIVE ATMOSPHERE.

5. Wiring Details.

5.1 Control panel.

The electrical control panel incorporates the facility to interlock with the door opening mechanism and automatically switch the air curtain on and off as the door is opened and closed. A pair of volt free auxiliary contacts are required on the door open/close contactor which closes as the door opens. If this is not available then a suitably positioned limit switch and striker plate will need to be fitted to the door.

The panel incorporates an auto/off/manual selector switch, which, when in 'auto' mode operates the air curtain as the door opens and closes. The 'manual' position overrides the door interlock, and the 'off' position turns the air curtain off.

The panel may also be fitted with optional low voltage (24V AC) relays for fire alarm/door contact interlocks. (Must be specified at time of ordering)

Note:

A job specific control panel wiring diagram is supplied inside the control panel.



6. Servicing.

! These appliances should be serviced annually by a competent person to ensure safe and efficient operation. In exceptionally dusty or polluted conditions more frequent servicing may be required. The manufacturer offers a maintenance service. Details available on request. **Isolate electricity supplies before commencing any work.**

6.1 Tools required.

The following tools and equipment are recommended to complete the tasks laid out in this manual.

! Suitable alternative tools may be used.



Cross point screwdriver



Small flat head screwdriver



13mm spanner



10mm spanner



Allen key set



Soft brush



Adjustable spanner

6.2 Air outlet louvres.

The air outlet louvres should be cleaned with a soft brush. Check that the louvres are set to the required angle. (See Figs. A/B on page 5 for setting procedure).

Check that the plug/socket connection to each fan (inside the unit) is tight and that the cable is in good condition. Switch control panel on and check air curtain operation in each selector switch position (auto/off/man, low/medium/high speed).

6.3 Air distribution fans.

The air distribution fans can be accessed by opening the fan access lid as described in section 7.1.

Clean off any dust or deposits with a soft brush paying particular attention to the impeller. Check that the impeller spins freely, and that there is no play in the fan bearings.

The fan(s) can be removed, if necessary, as described in section 7.1.

6.4 Electrical.

! **Isolate electricity supplies before commencing any work.**

Check condition and tightness of all terminations in control panel.

Remove the fan terminal box cover located on top of the air curtain (Fig.1), and repeat above procedure for the fan terminations.

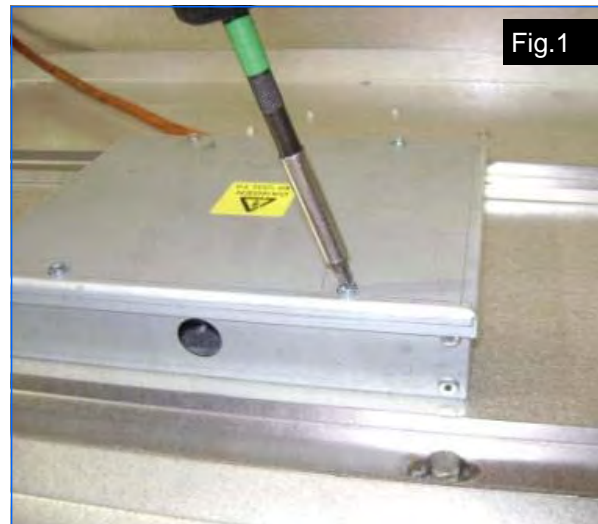
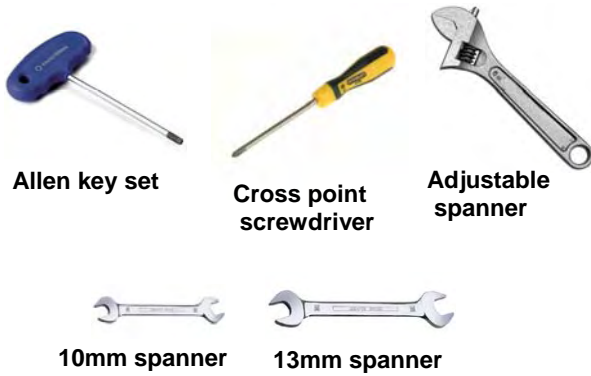

Fig. 1

7. Parts Replacement.

! All servicing/maintenance work on this air curtain should be carried out by suitably qualified person. Before commencing any work please ensure that the electricity supplies are turned off.

7.0 Tools required.



7.1 Air distribution fans.

The air distribution fans can be accessed by removing the three screws along the bottom edge of the air inlet grille (Fig.2), and the retaining screws securing the hinged lid on the underside of the air curtain next to the louvres (Fig.3).

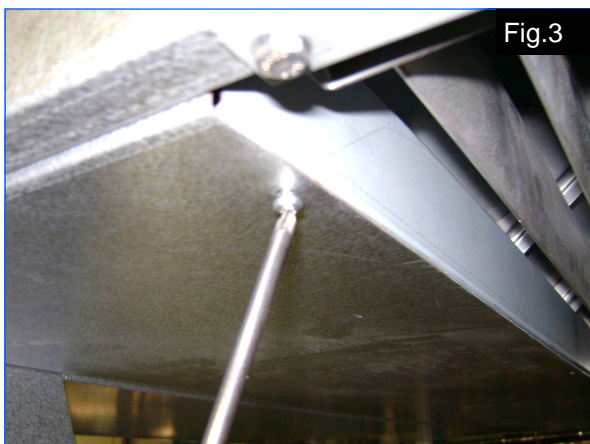
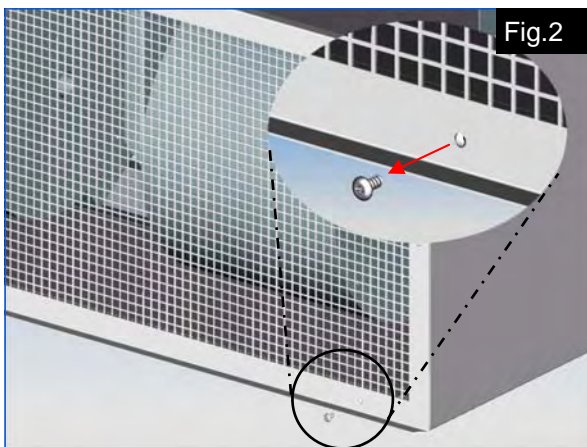

The lid can now be hinged down to access the fans as shown in Fig.4.

7.1.1 Fan closure plate

Before individual fans can be removed it will be necessary to remove the fan closure plate. Remove the retaining screws around the perimeter of the plate. (See Figs.5/6) The plate can now be removed.

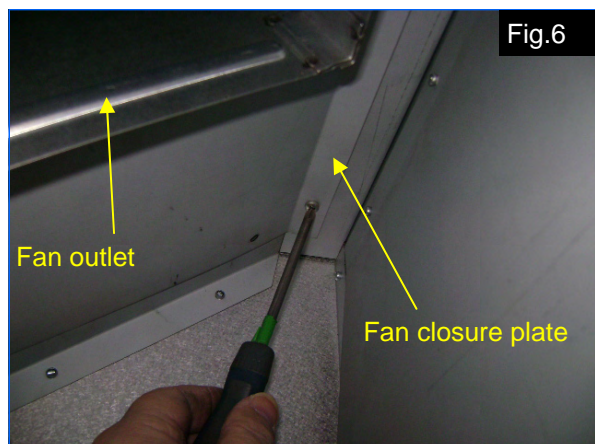
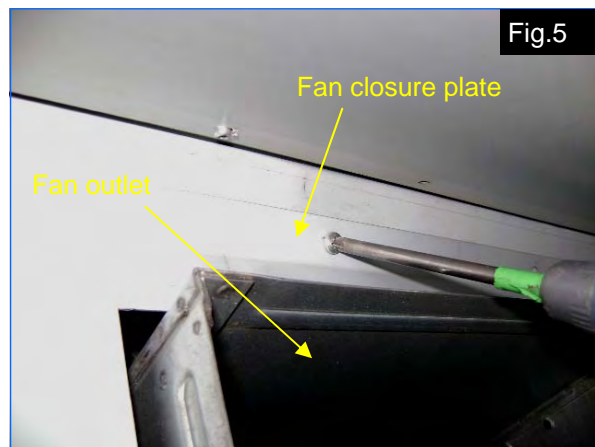

7. Parts Replacement cont.

7.1.2 Fan removal

Identify the feed cable for the fan requiring removal and disconnect it from its cable mounted plug/socket. (See Fig.7)

The four bolts securing the fan can now be removed as shown in Fig.8, and the fan removed from the air curtain downwards.

CAUTION: these fan units are heavy.

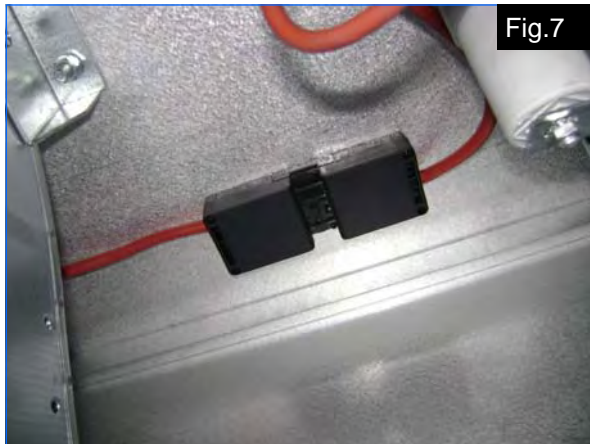

Fig.7

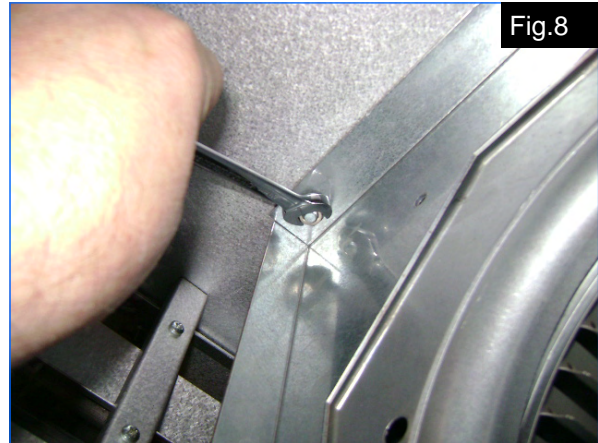

Fig.8

Fig.9 shows single air distribution fan in isolation for clarity.

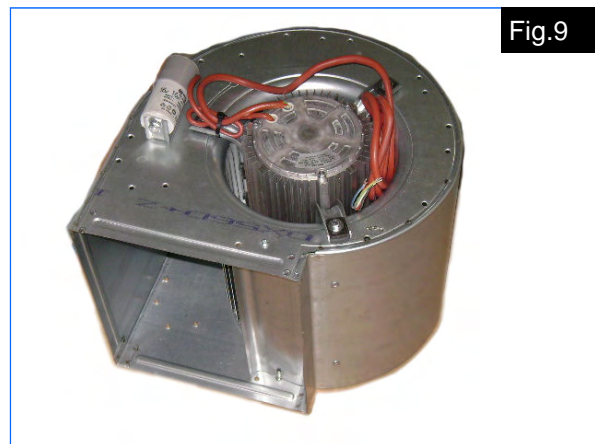



Fig.9

8. Spare Parts.

The air distribution fans and 5 pin plug/socket are available as a spare part as detailed below.

! *Note: Any spare parts or components used that are not approved by AmbiRad could invalidate the approval of the appliance and also the warranty.*

Item	Description	Part No.	Item	Description	Part No.
	3 speed air distribution fan unit	AB-FAN		Air distribution fan 5 pin plug/socket	Plug: 3127 Socket: 3126

9. Fault Finding.

Air distribution fans

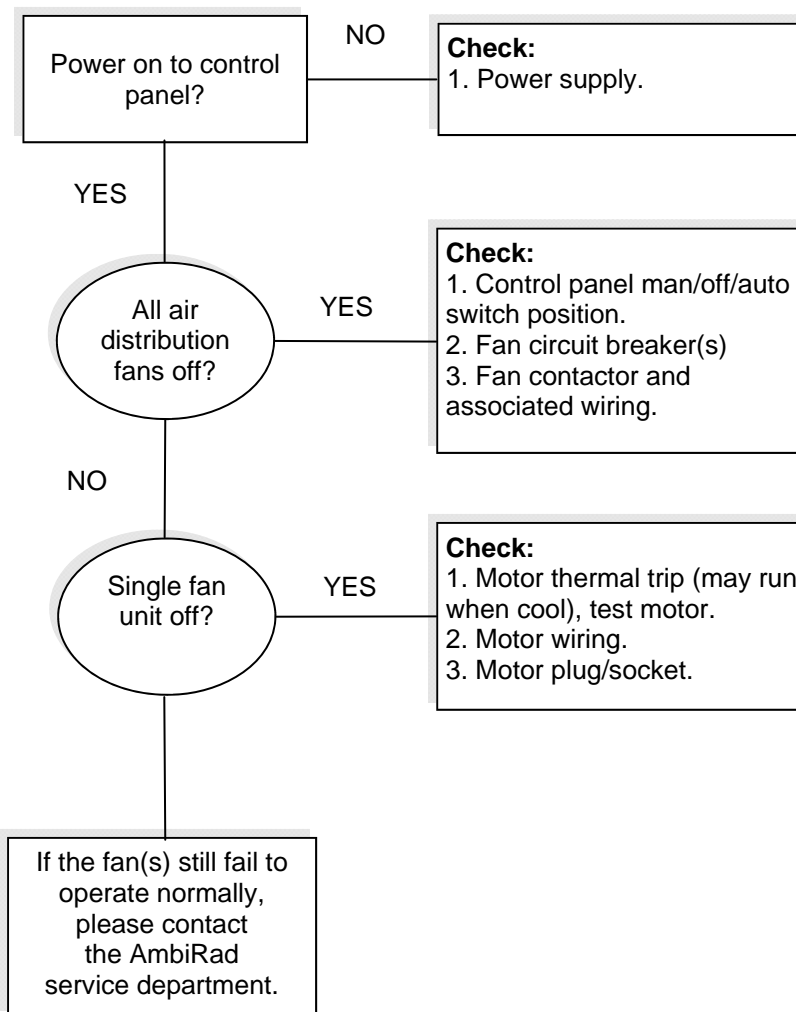

10. User Instructions.

10.1 Important information

This appliance must only be installed by a competent person in accordance with the requirements of the codes of practice and the rules in force in the country of use.

10.1.1 The appliance **must** be earthed.

10.1.2 Never rest anything, especially ladders, against the air curtain.

10.2 To start the AB air curtain (manual)

10.2.1 Rotate the control panel auto/off/manual selector switch is in the manual position.

10.2.2 Switch on electrical supply to the control panel. The panel live lamp will illuminate and the air distribution fans will start.

10.3 To start the AB air curtain (auto)

10.3.1 Rotate the control panel auto/off/manual selector switch is in the auto position.

10.3.2 Switch on electrical supply to the control panel. The panel live lamp will illuminate and the air distribution fans will only start if the door is in the raised position.

10.4 To switch off the AB air curtain

10.4.1 Rotate the auto/off/manual control panel selector switch to the 'off' position. The air distribution fans will stop. Switch off the electrical supply to the control panel. The panel live lamp will extinguish.

10.6 Servicing

To ensure continued efficient and safe operation it is recommended that the air curtain is serviced regularly by a competent person, once a year in normal working conditions, but in exceptionally dusty or polluted conditions more frequent servicing may be required.

The manufacturer, AmbiRad offers a maintenance service, details of which are available on request.

For sales related queries please contact the address given below.



WARNING:

THIS AIR CURTAIN SHOULD NOT BE INSTALLED WHERE THERE IS A CORROSIVE ATMOSPHERE.



NORTEK GLOBAL HVAC (UK) LTD
Fens Pool Avenue
Brierley Hill
West Midlands DY5 1QA
United Kingdom

Tel: 01384 489 250
Fax: 01384 489 707

airbloccsales@nortek.com
www.ambirad.uk

Document reference number GB/AIR/039/0716
Replaces GB/AIR/039/0214