

## INSTALLATION AND OPERATING MANUAL

# OUH Oil Fired Unit Heater

---

### WARNINGS

Reznor equipment must be installed and maintained in accordance with the current OFTEC

Regulations for oil fired products. Due account should also be taken of any obligations arising from the Health and Safety at Works Act 1974 or relevant codes of practice. In addition the installation must be carried out in accordance with the current IEE wiring regulations (BS 7671), BS 6896:

Industrial & Commercial) and any other relevant British Standards and Codes of Practice by a qualified installer. All external wiring MUST comply with the current IEE wiring regulations.

**Reznor® is a registered trademark of Nortek Global HVAC, LLC.**

Any reference made to Laws, Standards, Directives, Codes of Practice or other recommendations governing the application and installation of heating appliances and which may be referred to in Brochures, Specifications, Quotations, and Installation, Operation and Maintenance manuals is done so for information and guidance purposes only and should only be considered valid at the time of the publication. The Manufacturer cannot be held responsible from any matters arising from the revision to or introduction of new Laws, Standards, Directives, Codes of Practice or other recommendations.

**Bio fuel statement** - All our oil fired heater products are configured for use on both Class D light distillate fuel oil.

As a result of recent changes made to European legislation regarding the specification of class D heating oil to allow for the inclusion of 7% FAME (Fatty Acid Methyl Ester) i.e. bio fuel and effective from early 2011, all oil fired air heater products and installations maybe affected.

From April 2011 all our Suspended Oil fired Unit Heaters will be fitted with Riello burners which are bio fuel compatible for blends up to 10%.

Please note that the use of bio fuels may give rise to a number of installation issues, to both new and existing plant which could affect the warranty of the burner. We recommend that you familiarise yourself with current information from both the burner manufacturer Riello and OFTEC.

#### **IMPORTANT NOTICE TO INSTALLERS**

Installers should satisfy themselves that the oil pipework installation is carried out in accordance with all current legislation, Codes of Practice and recommendations .

<b>1.</b>	<b>Installation Requirements</b>	6
	1.1 Compliance notices	6
	1.2 Certificates of conformity	7
	1.3 General product information	7
	1.4 General requirements	7
	1.5 Delivery and pre-installation checks	8
	1.6 Warranty	8
	1.7 Health and Safety	9
	1.8 Location / Positioning	10
	1.9 Fuel supply - general	11
	1.9.1 Fuel	11
	1.9.2 Storage tank	11
	1.9.3 Single pipe system (gravity feed)	12
	1.9.4 Two pipe system	12
	1.9.5 Pressurised ring main system	12
	1.9.6 Pipe work and fittings	12
	1.10 Electrical supply	13
	1.11 Air supply	15
	1.11.1 Heaters installed within the heated space	15
	1.11.1.1 Natural Ventilation Openings to the Heated Space	15
	1.11.1.2 Mechanical Ventilation to the Heated Space	16
	1.11.2 Heaters Installed within a Plant Room or Enclosure	16
	1.11.2.1 Natural Ventilation Openings to Plant Rooms	16
	1.11.2.2 Natural Ventilation Openings to Enclosures	16
	1.11.2.3 Mechanical Ventilation to a Plant Room or Enclosure	16
	1.12 Air distribution system	17
	1.13 Flue system	17
	1.14 Dimensions	19
	1.15 Technical Details	21
	1.15.1 Reference Information	22
<b>2.</b>	<b>Installation</b>	23
	2.1 Packaging/siting	23
	2.2 Heater Mounting	23
	2.3 Minimum Clearances	23
	2.4 Warm Air Circulation	23
	2.5 Flue Installation	24
	2.6 Oil Installation/connection	24
	2.7 Electrical Installation/connection	24
	2.8 Heater Control Installation	24
<b>3.</b>	<b>Commissioning</b>	31
	3.1 Commissioning - Pretest	31
	3.2 Commissioning - Ignition	32
	3.3 Commissioning - air delivery system	33
	3.4 Commissioning - hand over	33

<b>4.</b>	<b>Servicing</b> .....	34
	4.1 Planned Servicing .....	34
	4.2 Servicing Procedure - Major Component Parts .....	34
	4.2.1 Flue.....	34
	4.2.2 Main Fan.....	35
	4.2.3 Heat Exchanger.....	35
	4.2.4 Electrical Supply.....	35
	4.2.5 Oil Supply .....	35
	4.2.6 Burner .....	36
	4.2.7 Air Delivery System.....	36
	4.2.8 Report.....	36
	4.3 Service Re-commissioning .....	36
<b>5</b>	<b>Parts Lists</b> .....	37
<b>6.</b>	<b>Fault Finding Guide</b> .....	39
<b>7.</b>	<b>Replacement Parts</b> .....	42
	7.1 Burner.....	42
	7.2 Controller.....	42
	7.3 Electrode Assembly.....	42
	7.4 Nozzle.....	43
	7.5 Photocell .....	43
	7.6 Oil Pump.....	43
	7.7 Contactor.....	44
	7.8 MCB .....	44
	7.9 Fan/Limit Stat Assembly.....	44
	7.10 Axial Fan.....	45
<b>8</b>	<b>User Instructions</b> .....	47
	8.1 Commissioning and hand over.....	47
	8.2 Servicing .....	47
	8.3 Start Up Procedure.....	47
	8.4 Stop procedure.....	48
	8.5 Shut down procedure .....	48
	8.6 Ventilation only .....	48
	8.7 Lockout situations .....	48

## Introduction

Welcome to the Suspended Oil fired Unit Heater Range. Local regulations may vary in the country of use and it is the installers responsibility to ensure that such regulations are satisfied

All installation, assembly, commissioning and service procedures must be carried out by suitable qualified competent persons to the statutory regulations in the country of use.

When installing, commissioning and servicing is undertaken on these heaters due care and attention is required to ensure that working at height regulations are adhered to at the mounting heights specified.

All Dimensions shown are in **mm** unless



**PLEASE READ** this document prior to installation and use. The safety of this heater is guaranteed only by the correct usage in accordance with these instructions, therefore it is recommended that they are retained for future reference.

The manufacturer reserves the right to alter specifications without prior notice.

# 1. Installation Requirements

## 1.1 Compliance notices

The Suspended Oil fired Unit Heater range detailed here with are manufactured within a strictly controlled quality environment within the parameters of ISO 9001.

These instructions are only valid if the following country code is on the appliance GB. IE. If this code is not present on the appliance, it is necessary to refer to the technical instructions which will provide the necessary information concerning the modification of then appliance to the conditions of use for the country.

The Suspended Oil fired Unit Heater range have been tested and assessed for compliance with the following European Directives.

- Machinery Directive: (2006/42/EC)
- Low Voltage Directive: (2006/95/EC)
- Electromagnetic Compatibility Directive: (2004/108/EC)
- Product Liability Directive (85/374/EEC)

The manufacturer has taken reasonable and practical steps to ensure that all Suspended Oil fired Unit Heaters are safe and without risk when properly used. These heaters should therefore only be used in the manner and purpose for which they were intended, and in accordance with the recommendations detailed herewith.

The Suspended Oil fired Unit Heater range has been designed, manufactured, assembled, inspected, and tested, with safety and quality in mind, there are certain basic precautions which the installer and user should be aware of, and they are strongly advised to read the appropriate sections of the information pack accompanying the heater, prior to installation or use.

The manufacturer supports all new products being supplied to their customers with a comprehensive information pack; this clearly defines mandatory instructions for the safe installation, use, and maintenance, of the appliance(s).

Where proprietary items are incorporated into any Suspended Oil fired Unit Heater, detailed information and instructions are also provided as part of the information pack.

It is the responsibility of the installer, owner, user, or hirer of a Suspended Oil fired Unit Heater to ensure that they are familiar with the appropriate information/manuals supplied by the manufacturer and the safety instructions. In addition, operators must be suitably trained in the use of the appliance so as to ensure its continued safe and efficient use.

The manufacturer has a commitment to continuous improvement and therefore reserve the right to amend or change the specification of the Suspended Oil fired Unit Heater subject to compliance with the appropriate European, national and local regulations

Contained within the text of the manual, the words 'Caution' and 'Warning' are used to highlight certain points.



Caution is used when failure to follow or implement the instruction(s) can lead to premature failure or damage to the heater or its component parts.



Warning is used when failure to heed or implement the instruction(s) can lead to not only component damage, but also to a hazardous situation being created where there is a risk of personal injury.

The Suspended Oil fired Unit Heater range conform to the following harmonised standards:

**BS EN 292-1**

Safety of Machinery - Basic Concepts, General Principles for Design Basic terminology, methodology BS EN 292-2

**BS EN 292-2**

Safety of Machinery - Basic Concepts, General Principles for Design Technical Principles and Specifications

**BS EN 60204-1**

Safety of Machinery - Electrical Equipment for Machines Specification for General Requirements

**BS EN 60335-1**

Safety of Household and Similar Electrical Appliances General Requirements

**BS EN 55014**

Limits and methods of measurement of radio disturbance characteristics of electrical motor-operated and thermal appliances for household and similar purposes, electrical tools and similar electric apparatus

**BS EN 50165**

Electrical Equipment of non-electric heating appliances for household and similar purposes, safety requirements

## 1.2 Certificates of conformity

Certificates of conformity are available from the manufacturer, address details are shown on the back page.

## 1.3 General product information

The Suspended Oil fired Unit Heater range have an output range from approximately 40.0 kW to 103kW. Each heater must be connected to its own individual open flue.

Each heater is fitted with a forced draught burner which has been test fired and pre-set prior to despatch. The safety functions of the burner are by way of a fully sequential control box fitted to the burner.



Neither asbestos nor soft soldered joints are used in the construction or manufacture of the Suspended Oil fired Unit Heater range. The materials selected for use can withstand the mechanical, chemical, and thermal stresses which they will be subject to during foreseen normal use when installed in accordance with the manufacturers recommendations.

## 1.4 General requirements



CAUTION

Ensure the fuel supply is in accordance with the manufacturer's recommendations and is as stated on the appliance data plate.



CAUTION

Installation, commissioning, and servicing must only be carried out by appropriately qualified and competent persons.



WARNING

Unauthorised modifications to the appliance, or departure from the manufacturers guidance on intended use, or, installation contrary to the manufacturers recommendations may constitute a hazard.



To ignore the warning and caution notices, and to ignore the advice from the manufacturer on installation, commissioning, servicing, or use, will jeopardise any applicable warranty, moreover, such a situation could also compromise the safe and efficient running of the appliance itself, and thereby constitute a hazard.

The installation of the appliance must meet all the relevant European, national, and local criteria.

**Prior to installation the following points should be considered;**

- The position of the heater for the optimum efficient distribution and circulation of warm air.
- The position of the heater relative to the route of the flue
- The position of the heater relative to the supply of fuel
- The position of the heater relative to the electrical services, and if appropriate, any additional controls.
- The position of the heater relative to the supply of fresh air
- The height if applicable at which the heater is to be mounted and potential stratification /circulation problems.
- The position of the heater relative to service and maintenance requirements

 The heater must not be installed within an area where the conditions are unsuitable, e.g. where the atmosphere is highly corrosive, has a high degree of salinity, or where high wind velocities may affect burner operation. Suitable protection should be provided for the appliance when it is located in a position where it may be susceptible to external mechanical damage from; for example, fork lift trucks, overhead cranes etc.

### 1.5 Delivery and pre-installation checks.

The heater is supplied wrapped in heavy duty protective polythene. On receipt of the heater, the following checks should be carried out;

- The model is as per order.
- That it is undamaged.
- That is suitable for the fuel supply.
- That is suitable for the electrical supply

If any of these points are not satisfied then contact should be made with the suppliers sales office as soon as possible by telephoning the number shown on the rear page. In the case of claims for damage, this must be signed for as damaged and reported in writing within 24 hours of delivery, in order to comply with insurance criteria.

### 1.6 Warranty

The heater is supplied with a 1 year parts and labour warranty and a further year on all parts excluding consumables. In addition to this there is a 10 year time related warranty on the combustion chamber.

The warranty commences from the date of dispatch from the manufacturer, and is subject to the terms detailed within the Manufactures 'conditions of business'.



**Note (i)** - The warranty may be invalidated if -

- The installation is not in accordance with the general requirements of this manual.
- The flue arrangement and air supply for the heater are not in accordance with the manufacturers recommendations, codes of practice, or similar standards.
- Air flow through the heater is not in accordance with the manufacturers technical specifications.
- Internal wiring on the heater has been tampered with or unauthorised service or repairs undertaken.
- The main electrical supply input to the heater has been interrupted during the heating mode.
- The heater has been subject to and affected by the ingress of water in any form.
- The heater is not operated at the rating(s) laid down in the manufacturers technical specifications.
- The heater has not been operated or used within the normal scope of its intended application.
- The manufacturer's recommended minimum service requirements have not been complied with





**Note (ii)** - All warranty claims must contain the following info to enable processing to take place

- Heater model
- Heater serial number
- Order reference/date of order, together with full installation details (name and address)
- Details or symptoms of fault
- Installers name and address.

Faulty parts must be returned to the supplier, the address of which is provided at the rear of this manual.

Any such parts will undergo inspection to verify the claim. Replacement parts supplied prior to this may be charged, and a credit supplied upon subsequent validation of the warranty claim.

Consumable items are specifically not included within the scope of the warranty.



**Note (iii)** - Notification is required immediately a fault is suspected.

The manufacturer will not accept responsibility for any additional damage that has been caused, expense incurred, or consequential loss resulting from any failure of the heater(s).

## 1.7 Health and Safety



The Suspended Oil fired Unit Heater range must be installed in accordance with the current OFTEC regulations for oil fired products Due account should also be taken of any obligations arising from the Health and Safety at Works Act 1974 or relevant codes of practice. In addition the installation must be carried out in accordance with the current IEE wiring regulations (BS 7671), BS 6896: (Industrial & Commercial) and any other relevant British Standards and Codes of Practice by a qualified installer. Isolate all electrical supplies to the heater & controller before proceeding.

For your own safety we recommend the use of safety boots and leather faced gloves when handling sharp or heavy items. The use of protective eye wear is also recommended.

In areas where it is proposed that more than one heater is to be installed, a general scheme of circulation should be drawn up and maintained, thereby offering the best heat distribution

All Suspended Oil fired Unit Heaters are fitted with a pressure relief facility, this is incorporated into the design of the flue gas exit duct.

Care should therefore be taken in siting service connections and controls well away from the pressure relief vent.



Under no circumstances must the pressure relief be restricted, blocked, or have the free exit of exhaust gas impaired or re-directed.



Before using this appliance:

- Check that the voltage indicated on the type plate corresponds to the mains supply voltage.
- Ensure that the heater has been securely fastened in its final mount position.



**UNDER NO CIRCUMSTANCES** should any item be placed on or above any part of the heater, whether the heater is being used or not. This appliance must be earthed.

## 1.8 Location / Positioning



All of the basic criteria must be satisfied prior to commencing installation and commissioning, additionally, the Suspended Oil fired Unit Heater must be positioned and installed so as to comply with all the relevant standards and guide lines (see section 1.1), as well as meeting national and local fire regulations and insurance criteria, especially if it is proposed that the heater is to be installed within a special risk area (e.g. proximity to where petrol engined vehicles are stored or parked, where cellulose spraying takes place, where woodworking machinery is operated, etc.).

Indirect heaters must not be located in hazardous areas, however, it is permissible for the heater to supply air to such areas.

The heater must not be installed within an environment where there is a high concentration of chlorides, fluorides, salts, or other aggressive or volatile chemicals/compounds. Nor should the heater be positioned where the burner could be adversely affected by high winds or draughts.

The location chosen for the heater must allow for the fitting of an effective flue system.

The location must also allow for adequate clearance for the air supply, return air circulation, oil supply and electrical supply, whilst also providing good and safe working access.

Suspended free blowing Unit Heaters are at their most effective when located as close to the working area as possible. However care should be exercised to avoid directing the discharged air directly onto the occupants of the area to be heated.

On exposed walls heaters should be positioned so as to discharge towards, or along the length of the exposed wall. In areas where it is proposed that more than one heater is to be installed, a general scheme of circulation should be drawn up and maintained, thereby offering the best heat distribution.

Air pressure within the area heated and the outside air pressure must remain the same, factors influencing this would be the presence of extraction systems, ventilation systems, and various types of process plant. OUHA 60-100 models can be installed to allow the fans to work in opposite directions. This enables the heater to be installed centrally in the area to be heated and allows warm air to be discharged to both the front and rear of the heater.

The heater must be installed on a flat and level surface made from non-combustible material, which is sufficiently robust to withstand the weight of the heater and any ancillary equipment. Any combustible material adjacent to the heater or flue system must be so placed or shielded so that its surface temperature does not exceed 65°C.

All pipe work must be constructed and installed so that it does not permit the ingress of air.

The construction, size, and position of the oil storage tank must take account of the current regulations, as well as suiting the requirements of the installation.

Please refer to pages 9 and 10 for additional information.



On pumped systems always check that the pump is correctly set up prior to running, and always ensure that valves are open allowing a free flow of oil through the system.

## 1.9 Fuel supply - general

The Suspended Oil fired Unit Heater range are all manufactured and pre-set for use with either 28 second or 35 second gas oil delivered to the burner via a suitable piped system from the oil storage tank.



Galvanised or plastic pipe work and fittings must not be used. (see BS 5410 Part 1 1997)

The constraints of the application will, to a large extent, determine whether it is preferable to use a single pipe gravity feed system, or whether the two pipe pumped system is more appropriate.

Where more than one appliance is to share a common supply it will be necessary to use a pressurised ring main system.

### 1.9.1 Fuel

In order to promote trouble free operating it is necessary that the oil within the storage tank and oil line does not fall below the cold filter plugging point (cfpp), in this country and with class D fuel (also referred to as gas oil). The critical temperature is  $-4^{\circ}\text{C}$  for this summer grade. The cfpp critical temperature for the winter grade is  $-12^{\circ}\text{C}$ . If summer grade fuel is stored for winter use in areas prone to severe frosts and low temperatures it will be necessary to insulate or even heat the supply tank and pipe work.



The fuel supplier should be contacted prior to installation so that any requirements concerning delivery, transport, storage and use can be addressed before work commences.



The inlet pump pressure must not exceed a maximum of 0.4 bar, this is because beyond this point gas is liberated from the oil.

### 1.9.2 Storage tank

An externally painted steel storage tank to BS 799 part 5 1987 or a medium density polyethylene oil tank OFTEC certified to OFS T-100 may be used. Local, national, European and fire regulations must also be complied with and must include:

- A fuel level gauge (not made from glass) a vent pipe with a diameter greater than that of the filler and featuring a weatherproof termination.
- A sludge valve.
- An outlet valve situated at the opposite end of the tank to the sludge valve.
- A filler pipe connection situated at the opposite end to the outlet valve.

The size of the storage tank must take account of the estimated consumption and any quantity price breaks offered by the oil supplier.

It is preferable to install the tank outside, however, if this is not practicable and the tank has to be installed indoors advice must be sought about its siting, especially so far as fire regulations are concerned.

If a separate fire resistant chamber cannot be provided for indoor installations, a catchment pit with a capacity 10% greater than that of the storage tank must be provided

Storage tanks can if necessary be sited on a roof, but this is subject to special regulations as well as local authority approval and compliance with fire regulations, reference to BS 5410 part 2 1978 & part 1 1997 is strongly suggested.

It is advisable to leave the tank unpainted on the inside, but to paint the outside with a proprietary grade of anti-corrosive paint.



A galvanised or open topped tank is strictly not allowed.  
All oil storage tanks require a bund

The Control of Pollution Regulation (Oil Storage) 2001 should be consulted prior to installation.

### 1.9.3 Single pipe system (gravity feed)

For installations where the oil tank is 200mm or more above the level of the fuel pump the principle of gravity feed may be used.

The draw off point for the supply to the burner must not be positioned any lower than 100mm above the bottom of the tank.

Where a return valve is fitted this must be tamper proof to prevent inadvertent operation.

 If the valve is closed when the pump is running the oil pressure can be increased sufficiently so as to cause damage to the seals within the pump.

The return oil should preferably be discharged through an elbow onto a tank plate situated within the tank, this should be positioned so as not to introduce air or air bubbles into the draw off pipe.

### 1.9.4 Two pipe system

This is used where the oil storage tank is lower than the pump.

Access for the fuel feed to the burner should be via a suitable tapping made in the top of the tank, and the fuel feed pipe should extend to not less than 100mm above the bottom of the tank.

A non return valve with a metal to metal seat should be fitted, especially if the return pipe work is terminated at a level above the draw off tube. The non- return valve must be removable for service and maintenance purposes, and the return pipe from the pump must therefore be extended down into the tank to the same level as the suction pipe.

The presence of a tamper proof isolating valve fitted within the return pipe is only required if there is a risk that oil will siphon out of the tank if the return pipe is disconnected at the pump during maintenance or servicing and if the non return valve has been omitted.

 The Deareator must be fitted the burner side of the inlet fuel filter

Maximum lift should not exceed 3.5 metres, and the vacuum should not exceed 0.4 bar.

Each heater must have a separate fuel supply.

 It is strongly recommended that the separate manual concerning the operational details of the burner supplied with the heater as part of the information package is studied prior to installation.

### 1.9.5 Pressurised ring main system

This system is used to supply a number of units from a common storage tank.

A booster pump is used to provide the pressure to push the oil around the ring main and back to the tank.

Pressure reducing valves should be fitted on the delivery pipe to each heater to ensure that the pressure at the burner pump is less than 6 psi.

 The internal by-pass plug must be removed from the burner pump when used in a pressurised ring main application.

### 1.9.6 Pipe work and fittings

 Galvanised or plastic pipe work and fittings must not be used. (see BS 5410 Part 1 1997)

 All joints must be sealed properly, if necessary using PTFE tape or other approved sealing media.  
The pipe work must be effectively sealed so as to prevent the ingress of air.

 It is advisable to check all pipe work prior to installation to ensure that there is no loose debris or scale present.

**Black iron pipes can be hammered to assist in the removal of these contaminants.**

 The oil feed to each heater must be fitted with a fire check valve and isolating valve.  
Any waste oil or sludge must be disposed of correctly.

 CAUTION The fire check valve must be operated by way of a fusible link positioned so that it is above the burner.

 WARNING Never dispose of it by dumping or tipping it down drains or into watercourses where ground water can become polluted and environmental damage caused.

## 1.10 Electrical supply

Wiring external to the Suspended Oil fired Unit Heater must be installed in accordance with any local, national, and European regulations, as well as meeting the appropriate requirements of IEE regulations.

 CAUTION The means of connection to the main electrical supply must allow for complete electrical isolation of the heater, furthermore, in the case of a unit wired for a three phase supply, the supply should only be used to serve the heater itself and no other plant or equipment. The position of the isolation switch must be such that it is adjacent to the heater and easily accessible at all times. In addition, the isolator itself must have a contact separation of not less than 3mm.(as per BS5991 clause 20.2).

The Control fuse ratings are detailed on the appliance data plate.

 WARNING Ensure that the electric and oil supplies are turned off before any electrical work is carried out on the heater.

 CAUTION Ensure that wiring cannot make contact with any surfaces liable to be subject to high temperatures or where the insulation of the wiring could be impaired as a result of such contact.

 WARNING All connections must be checked to ensure that they are secure, and free from corrosion.  
Terminals and connections should also be checked to ensure that no stray strands are bridging terminals.

 CAUTION Final connections for any additional external controls must be completed on site, and must be carried out according to IEE regulations.

Separate user information is provided for the time control unit and the burner, and forms part of the product information pack which accompanies every heater when despatched.

 WARNING All heaters are supplied fused and pre-wired, all must be earthed.

 CAUTION The main electrical supply must not be switched off or disconnected as a method for stopping the heater, the exception to this is in an emergency, or during servicing, when the heat exchanger has been allowed to cool sufficiently to prevent any damage from occurring. Claims for damage will not be considered if they have resulted from incorrect wiring or the incorrect use of the heater.

 WARNING Always ensure that the appropriate personal protective equipment is used.

## Burner oil pump details for heater models 30 - 180 oil lines

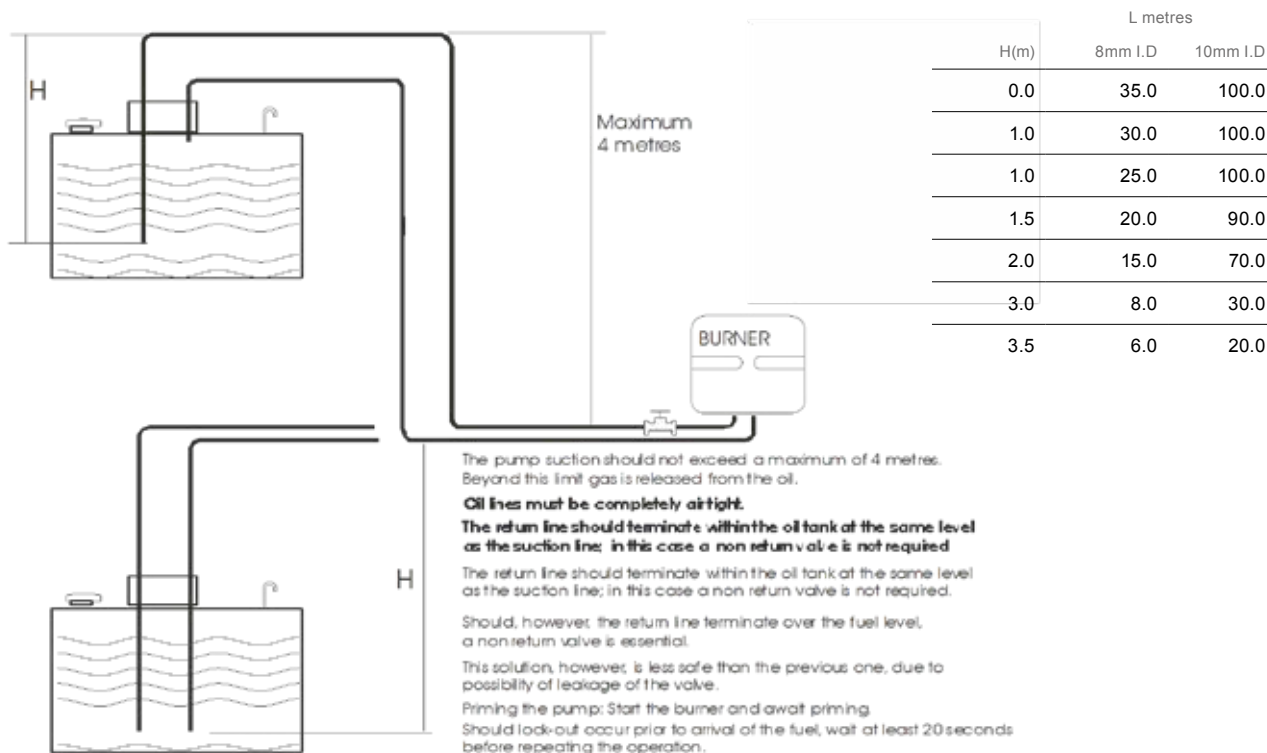

## Burner oil pump details 205 - 375 suction feed

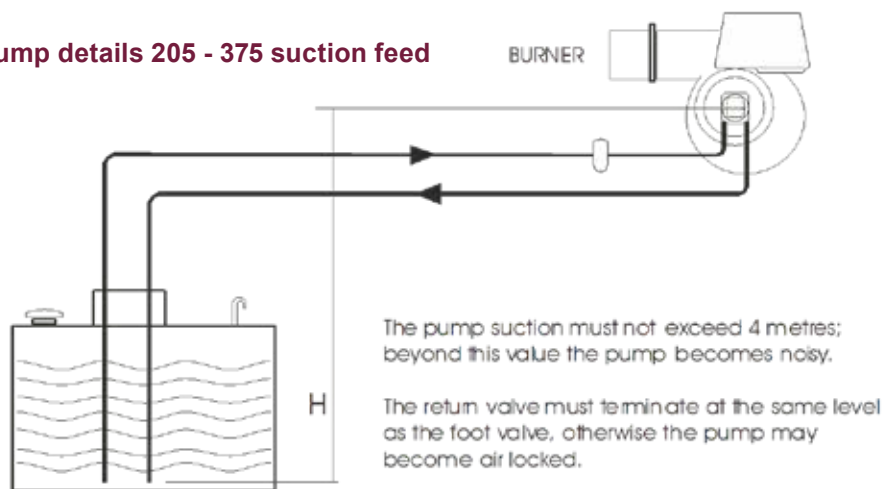

## Pressurised oil feed system

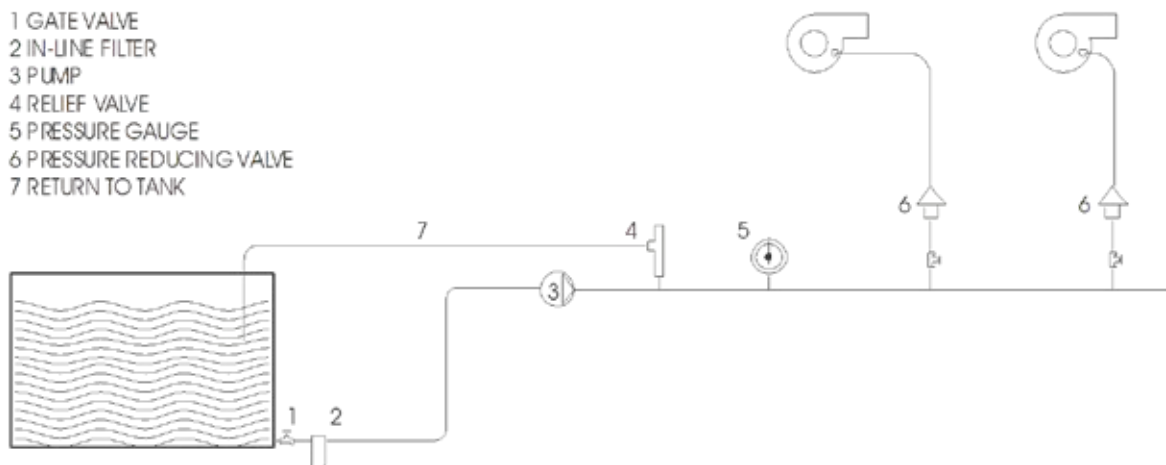

## 1.11 Air supply

Consideration must be given to the provision of air for the purposes of combustion and ventilation of the heated space, plant room or enclosure where heaters are to be installed. It is a requirement that the area where the air heater is located must have a permanent air vent of negligible resistance direct to the outside air.

Such air vents must be positioned so as not to become blocked or flooded, nor should they be placed so as to introduce undesirable matter (e.g. flammable, volatile, or aggressive chemicals/compounds or potentially hazardous or harmful substances) either direct from the outside, or through their proximity to an adjacent extraction system.

 It is strongly recommended that BS6230 is referred to for further information concerning ventilation requirements

Where mechanical ventilation is used it is a requirement that the inlet is of the mechanical type, and the outlet is either mechanical or natural.

### 1.11.1 Heaters installed within the heated space.

Where heaters are installed within the space to be heated (i.e. not a plant room or enclosure) then:

#### 1.11.1.1 Natural Ventilation Openings to the Heated Space.

If the heated space design air change rate is less than 0.5 air changes per hour then provision for low level natural ventilation openings will only be necessary.

**Combustion air or heater related ventilation air will not be required if -**

The design air change rate of the heated space is 0.5 air changes per hour or greater **OR** The design air change rate may be satisfied by natural infiltration or by mechanical ventilation

**Combustion and General ventilation will be required if -**

The design air change rate of the heated space is less than 0.5 air changes per hour **OR** Where the heated space has an air change rate of less than 0.5 air changes per hour then it will be necessary to provide either natural ventilation openings to the heated space (section 1.11.1.1. refers) or the mechanical ventilation of the heated space (section 1.11.1.2. refers)

The minimum free area of the low level natural ventilation opening shall be:

#### 2cm<sup>2</sup> for each kW of rated heat input

The low level natural ventilation opening should be situated on an external wall and be within 1000 mm of floor level.

The following table provides specific data for each heater model as -

Model	Minimum Free Area of ventilation opening	
	High Level cm <sup>2</sup>	Low Level cm <sup>2</sup>
40	None	88
60	None	128
70	None	166
90	None	192
100	None	230

**1.11.1.2 Mechanical Ventilation to the Heated Space.**

In the event that the heated space has a design air change of less than 0.5 air changes per hour and that installer prefers to mechanically ventilate the heated space rather than provide ventilation openings then:-

- The heated space needs to be mechanically ventilated so that the design air change is 0.5 air changes or greater.
- It is a requirement that the mechanical ventilation shall be of the 'input' type with either natural or mechanical extraction.
- Systems of mechanical extraction with a natural inlet shall not be used.

It is necessary to provide an automatic means to safely inhibit heater(s) operation should mechanical air supply fail for any reason.

**1.11.2 Heaters Installed within a Plant Room or Enclosure.**

A plant room means a room housing the heater plant and probably other items of building service plant and would generally have generous space for maintenance.

An enclosure is where the heater is installed within a compartment or confined area where space is limited. Where heaters are installed within a plant room or enclosure then provision for both combustion air and air for general ventilation will be required by means of high and low level ventilation openings (sections 1.11.2.1 refers to plant room applications and sections 1.11.2.2 refers to enclosure applications).

Alternatively the plant room or enclosure may be mechanically ventilated (section 1.11.2.3 refers).

**1.11.2.1 Natural Ventilation Openings to Plant Rooms**

For plant room applications the minimum free area of ventilation opening shall be:

- At high level 2 cm<sup>2</sup> for each kW of rated heat input.
- At low level 4 cm<sup>2</sup> for each kW of rated heat input.

The high level ventilation opening should be sited on an external wall and positioned as high as is practical and always within the top 15% of the wall height.

The low level natural ventilation opening should be situated on an external wall and be within 1000 mm of floor level.

The table below provides specific data for each heater model as -

Model	Minimum Free Area of ventilation opening	
	High Level cm <sup>2</sup>	Low Level cm <sup>2</sup>
40	88	176
60	128	258
70	166	332
90	192	384
100	230	460

**1.11.2.2 Natural Ventilation Openings to Enclosures**

For enclosure applications the minimum free area of ventilation opening shall be:

- At high level 5 cm<sup>2</sup> for each kW of rated heat input.
- At low level 10 cm<sup>2</sup> for each kW of rated heat input.

The high level ventilation opening should be sited on an external wall and positioned as high as is practical and always within the top 15% of the wall height

The low level natural ventilation opening should be situated on an external wall and be within 1000 mm of floor level.

The table in the next column provides specific data for each heater model as:-

Model	Minimum Free Area of ventilation opening	
	High Level cm <sup>2</sup>	Low Level cm <sup>2</sup>
40	220	440
60	320	640
70	415	830
90	480	960
100	575	1150

**1.11.2.3 Mechanical Ventilation to a Plant Room or Enclosure.**



In the event that the installer prefers to mechanically ventilate the plant room or enclosure rather than provide ventilation openings then:-

The plant room or enclosure needs to be mechanically ventilated at the rate of 4.14 m<sup>3</sup>/h of fresh air per kW or rated heat input.

It is a requirement that the mechanical ventilation shall be of the 'input' type with either natural or mechanical extraction. Where mechanical extraction is selected then the extraction rate should be 5%-10% less than the input rate.

Systems of mechanical extraction with a natural inlet shall not be used

It is necessary to provide an automatic means to safely inhibit heater(s) operation should mechanical air supply fail for any reason

The table to follow provides specific data for each heater model as -

Model	Mechanical Ventilation Rate for Plant Room or Enclosure
	M <sup>3</sup> /h
40	182
60	265
70	344
90	397
100	476

## 1.12 Air distribution system

The air heater should be positioned to enable maximum circulation of discharged warm air within the area to be heated, whilst taking account of personnel within the area, sources of cold air ingress, and obstructions.



Ensure louvres are adjusted outwards and ensure blades are not resonating

The air temperature rise on passing the heat exchanger is typically around 34°C

A full and unobstructed return air path to the air heater must be provided (see 1.11 Air Supply).

Where the heater is positioned to deliver blown air through an opening in a wall, return air intakes should be located so that they cannot become blocked. Similarly these intakes must be positioned so as not to draw in odours, fumes, hazardous vapours or particles.

## 1.13 Flue system.



It is essential that the products of combustion are flued to the outside of the building. Each heater must have its own separate flue, with a flue diameter of not less than is detailed in section 1.15 within this manual.

The minimum vertical length of flue must not be less than 1m. The flue should rise vertically, and the number of bends should be kept to a minimum.



It is strongly advised that BS 5854; 1980, and BS 5440; parts 1 and 2, are used as consultative documents when considering flue requirements.

Care should be taken to ensure that the flue terminal is not situated in a high-pressure area, the proximity of buildings and other obstacles which will influence this must be taken into account, preferably at the design stage.

Provision must be made for the disconnection of the flue for inspection and service requirements, and it is strongly advised that where bends are fitted inspection covers are included.

- Flue should be supported at intervals not exceeding 1.8 mtrs

The materials from which the flue is constructed must be non-combustible, resistant to internal and external corrosion, and be capable of withstanding the stresses and loadings associated with normal use. When designing the flue system the prevention of the formation and entrapment of condensation must be a key consideration.

- Twin wall or insulated systems are recommended, as they tend to inhibit the formation of condensates.

Where condensation is unavoidable traps should be included to encourage the condensates to flow freely to a point from which they may be released, preferably into a gully. The condensate pipe from the flue to the disposal point must be made from corrosion resistant pipe of not less than the internal diameter of the drain pipe.

If the flue passes through a wall, ceiling, or roof made from combustible material then it has to be sleeved so as to provide a minimum of a 25mm void between the exterior of the flue and the internal wall of the sleeve. The maximum permitted temperature of any adjacent combustible material is 65°C.

The position of the flue and its terminal should be such that it does not impair the combustion process. It should terminate in an exposed position so as to allow the escape and dissipation of flue gases without risk of their re-entering the property through windows, ventilation ports, etc. The flue should extend to at least 1m above the height of any object within 3.5m of the terminal.

Flue terminals should be fitted on all flues, the terminal must be of the approved type, and have outlet grilles on all sides giving a total free area of at least double that of the flue.



It is imperative that the flue should be properly sealed where it passes through the roof, this can best be achieved by using the approved method of roof flashing plate and cravat.



It should be noted that claims made under warranty and attributed to the ingress of water may not be considered especially if an approved method of sealing has not been used, or if the design of the flue has not made provision for possible condensation problems.

# 1.14 Dimensions

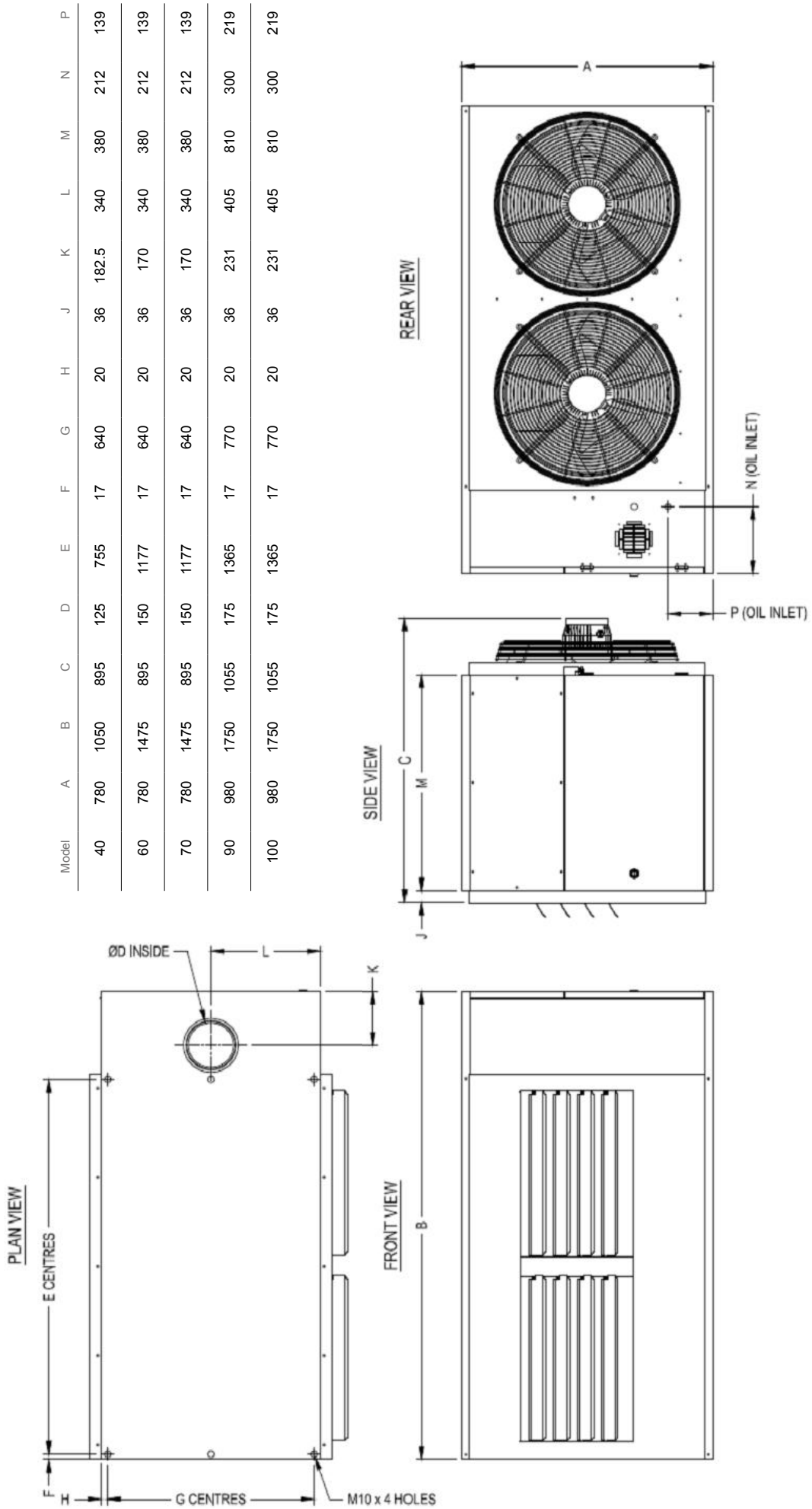

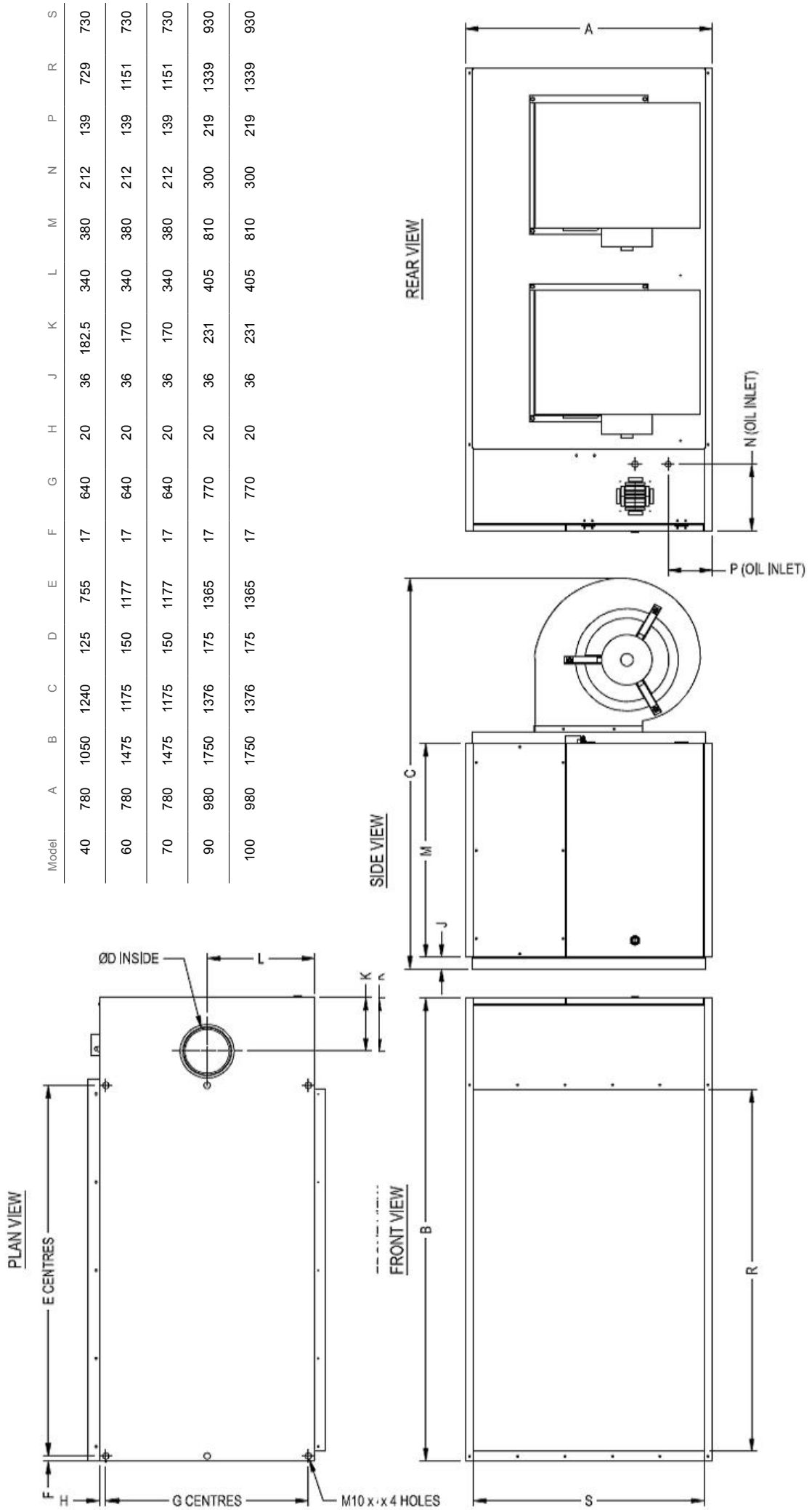

## 1.15 Technical Details

			40	60	70	90	100
Heat Output (max)	High Fire	kW/hr	39.09	58.79	70.45	85.90	102.50
		hr	133,380.62	200,599.81	240,385.38	293,102.97	349,744.52
	Low Fire	kW/hr	31.38	47.28	57.93	59.30	79.34
		hr	107,073.00	161,326.06	197,665.36	202,340.00	270,721
Heat Input (gross)	High Fire	kW/hr	46.01	68.34	84.19	99.95	120.63
		hr	156,992.64	233,185.76	287,268.20	341,043.56	411,606.65
	Low Fire	kW/hr	36.13	54.04	67.53	68.01	91.13
		hr	123,280.68	184,392.13	230,421.92	232,059.75	310,935
Heat Input (nett)	High Fire	kW/hr	43.16	64.12	78.99	93.77	114.80
		hr	147,268.03	218,786.52	269,525.07	319,956.52	391,713.86
	Low Fire	kW/hr	33.90	50.70	63.36	63.80	85.5
		hr	115,671.60	172,995.58	216,193.29	217,694.64	291,762
Nett Efficiency	High Fire	%	90.56	91.68	89.19	91.60	91.00
	Low Fire	%	92.58	93.26	91.43	92.34	92.00
Fuel Consumption 28s	High Fire	Imp gall/hr	1.34	1.89	2.21	2.85	3.47
		litre/hr	5.09	7.17	8.37	10.79	13.15
	Low Fire	Imp gall/hr	0.85	1.51	1.76	2.02	2.52
		litre/hr	3.21	5.72	6.67	7.63	9.53
Fuel Consumption 35s	High Fire	Imp gall/hr	1.23	1.75	2.21	2.54	3.05
		litre/hr	4.67	6.61	8.37	9.61	11.53
	Low Fire	Imp gall/hr	0.97	1.43	1.80	1.49	11.53
		litre/hr	3.68	5.41	6.80	5.64	230.00
Burner Pressure 28s	High Fire	Psi	160.00	160.00	160.00	160.00	160.00
		Bar	11.03	11.03	11.03	11.03	11.03
	Low Fire	Psi	100.00	100	100	100	100
		Bar	6.89	6.89	6.89	6.89	6.89
Burner Pressure 35s	High Fire	Psi	217.00	195.00	217.00	230.00	230.00
		Bar	14.96	13.44	14.96	15.86	15.86
	Low Fire	Psi	130.00	130.00	130.00	130.00	130.00
		Bar	8.96	8.96	8.96	8.96	8.96
Head Setting 0 flue resistance	High Fire	Number	5.00	0	4	0	0
	Low Fire	Number	5.00	0	4	0	0
Air setting 28s 0 flue resistance	High Fire	Number	4.00	3.00	3.00	2	2
	Low Fire	Number	0.75	-	-	0.25	0.25
Air setting 35s 0 flue resistance	High Fire	Number	3.00	3.00	3.00	2	2.0
	Low Fire	Number	0.50	0.75	0.80	0.25	0.25
Temp. Rise Through Heater	High Fire	°C	31.70	30.40	30.60	29.50	32.20
	Low Fire	°C	25.40	24.40	25.20	20.40	25.60
Burner Type		Riello	RG1RKD	RG2D	RG2D	RG3D	RG3D
Nozzle Size 35s			0.85x45°S	1.25x60°S	1.5x60°S	1.75x60°S	2x60°S
Nozzle Size 28s			1.1x45°S	1.5x60°S	1.75x60°S	2x60°S	2.5x60°S
Air Flow (std)	m		1.02	1.6	1.9	2.4	2.63
	ft		200.7874019	314.9606304	374.0157486	472.4409456	517.7165362
Air Throw (approx)	m³/sec		23	31	37	36	39
	ft³/min		75.45932	101.70604	121.39108	118.11024	127.95276
Sound Level	dBA		74.7	72	72	71	72
Seasonal Efficiency	Number%		73.4	74.9	72.6	76.3	74.0
Combustion Chamber	mbar		0.14	0.14	0.14	0.14	0.14

(\*Based on calculation

## 1.15.1 Reference Information

Doc/Ref	Title/Subject
BS 5410-1 & -2	Code of Practice for Oil firing
BS EN 292-1 &-2	Safety of Machinery
BS EN 60204-1	Safety of Machinery - Electrical
BS EN 60335-1	Safety of Electrical Appliances
BS EN 55014	Electromagnetic Compatibility
BS EN 50165	Safety of Electrical Equipment
BS 5854	Code of Practice - Flues/Flue Structures
BS 799-5	Oil Burning Equipment - oil tanks
OFTEC OFS T-10	Polyethylene oil storage tanks
BS 715	Metal Flue Pipes and Fittings
BS 5440-1	Specification/Installation of Flues
BS 5440-2	Ventilation Requirements Gas Appliances
BS779	Oil Burning Equipment - Burners
ISO 228/1	Pipe Threads Seals and Couplings

See also BS 2779 and BS 5380)

## 2. Installation

It is strongly advised that the installer reads Section 1 of this manual prior to starting any installation work. It is a requirement that only qualified and competent personnel undertake installation, commissioning, and servicing.



Always ensure that the appropriate personal protective equipment is used.

### 2.1 Packaging/siting

The heater will usually be supplied wrapped in heavy gauge polythene, non assembled parts will be supplied separately.

Prior to installation, the assembly of the heater should be completed, it is advisable that this is undertaken in the area where the heater is scheduled to be sited.



The Heater must be installed within the mounting heights indicated below in metres.

Model	Min	Max
40	2.0	2.7
60	2.4	3.0
70	2.4	3.5
90	2.5	3.5
100	2.4	3.5

The following clearances in mm must be observed \*when suspended:

### 2.2 Heater Mounting

The heater and flue must be adequately supported by one of the following methods;

- Suspension by steel drop rods or straps from the M10 fixing points located on top of the heater. These must be of sufficient strength to safely carry the weight of the unit and ancillary equipment. The straps may only drop vertically to eyebolts, if used; I.E.
- They must not be joined to the eyebolt at an angle to the vertical, and eyebolts, if used, should be of an approved type.
- OUH heaters can be mounted on specifically designed cantilever wall or vertical stanchion brackets which locate directly to the four M10 fixings on the heater casing. Alternatively OUHA or OUHC units can be mounted on cantilever type wall brackets however consideration must be given to ensure that the bracket is large enough to support the heater whilst providing the necessary clearances.
- In either case the installer should ensure that the wall wall fixings or other support medium is capable of supporting the weight
- On a level non-combustible surface capable of adequately supporting the weight of the unit and ancillary equipment.

### 2.3 Minimum Clearances

The following minimum clearances (in millimetres) are recommended when installing the heater. →

Model	40	60	70	90	100
Above	300				
Below*	300				
RHS	680			810	
LHS	250				
Rear OUHA	400	560			
Rear OUHC	200				

### 2.4 Warm Air Circulation

The air heater should be positioned to enable maximum circulation of discharged warm air within the area to be heated, whilst taking account of personnel within the area, sources of cold air ingress, and obstructions.



Ensure louvres are adjusted outwards and ensure blades are not resonating

The air temperature rise on passing the heat exchanger is typically around 34°C. A full and unobstructed return air path to the air heater must be provided (see 1.11 Air Supply).

Where the heater is positioned to deliver blown air through an opening in a wall, return air intakes should be located so that they cannot become blocked. Similarly these intakes must be positioned so as not to draw in odours, fumes, hazardous vapours or particles.

## 2.5 Flue Installation

An integral flue spigot is fitted to all the Suspended Oil fired Unit Heater thereby allowing the flue to connect directly to the heater.

The design of the flue must ensure that it can be disconnected to allow for cleaning and servicing, furthermore, all of the flue section joint sockets must face upwards, and the seal between the sections achieved through mechanical joints or through the use of approved caulking string and grout.



It is strongly advised that BS 5854 and BS 5440 parts 1 and 2 are referred to.

Where condensation is likely to be a problem provision should be made preferably at the design stage (see section 1.13)

## 2.6 Oil Installation/connection

The oil tank must be positioned so that there is a fall of 7.5mm (+/- 2.5mm) for every 30mm away from the outlet and towards the sludge/drain valve, which must be sited at the lowest point in the tank. If the tank is positioned on supports then there must be an adequate protective layer between tank and support to prevent damage or deterioration through corrosion.

It is strongly suggested that reference is made to BS 5410 ; part 2 ; 1978. It is also suggested that the installer is familiar with the detail and requirements contained within sections 1.9 of this manual prior to commencing installation.



Prolonged exposure and contact with Gas Oil can result in the natural oils being removed from the skin, sensitisation can result in dermatitis.

Always ensure that the appropriate personal protective equipment is used.

## 2.7 Electrical Installation/connection

**The Suspended Oil fired Unit Heater range is only available in 230V 50Hz 1PH.**

It is recommended that reference is made to the wiring diagrams contained within section 2.9 of this manual prior to installation or connection to the supply. The electrical supply must be as specified and suitable for the heater, and must be run within conduit to a point adjacent to the heater, and be terminated to provide an isolation point that will prevent remote or inadvertent activation.

- Cables, conduit, and fittings that are used to make the connection between the isolator and the heater must conform to the appropriate IEE regulations.
- All heaters are supplied fused and pre-wired, all must be earthed.
- Final connections for any additional external controls must be completed on site, and must be carried out according to IEE regulations.
- Separate user information is provided for the time control unit and the burner, and forms part of the product information pack which accompanies every heater when despatched.



Always isolate from mains electrical supply before commencing work on the heater.

Always ensure that the appropriate personal protective equipment is used.

## 2.8 Heater Control Installation



Isolate heater from mains before undertaking any electrical work.

Unless specified all unit Heaters are manufactured and supplied with a remote controllers to be wired back to the heater.

Refer to Controller instruction manual for full installation details. See following section for individual wiring diagrams.



Wiring diagram 7365021  
 OUHEC 60-100 Hi Lo Riello Oil  
 Burner  
 230/50/1ph

12 Way Terminal Block In Heater -  
 For Interconnections See Drawing:  
 7365025 for optional SMARTCOM MZ control panel wiring.  
 7365026 for optional NO control panel wiring

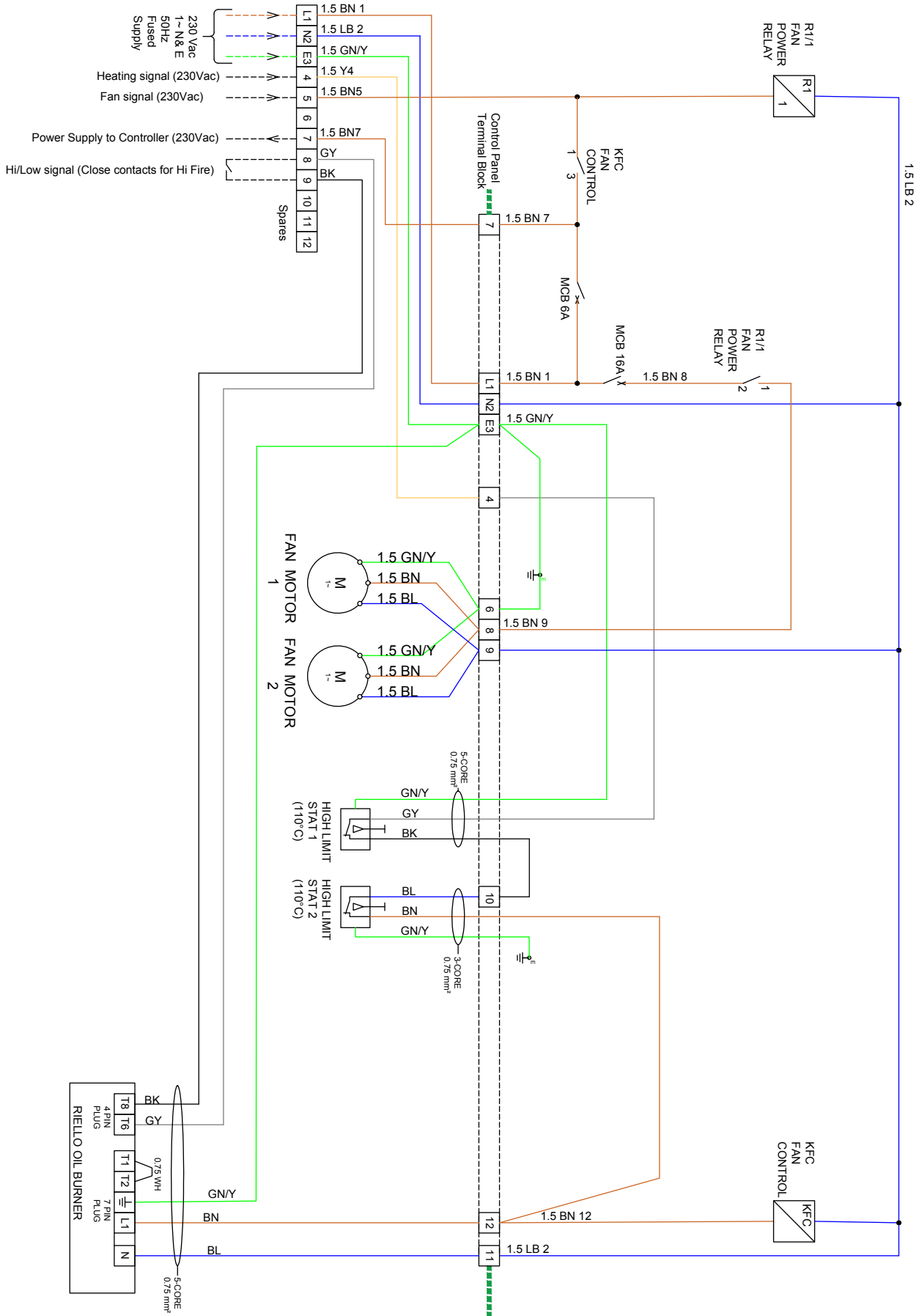

Wiring diagram 7365022  
 OUHEA 90-100 Hi Lo Riello Oil  
 Burner  
 230/50/1ph

12 Way Terminal Block In Heater -  
 For Interconnections See Drawing:  
 7365025 for optional SMARTCOM MZ control panel wiring.  
 7365026 for optional NO control panel wiring

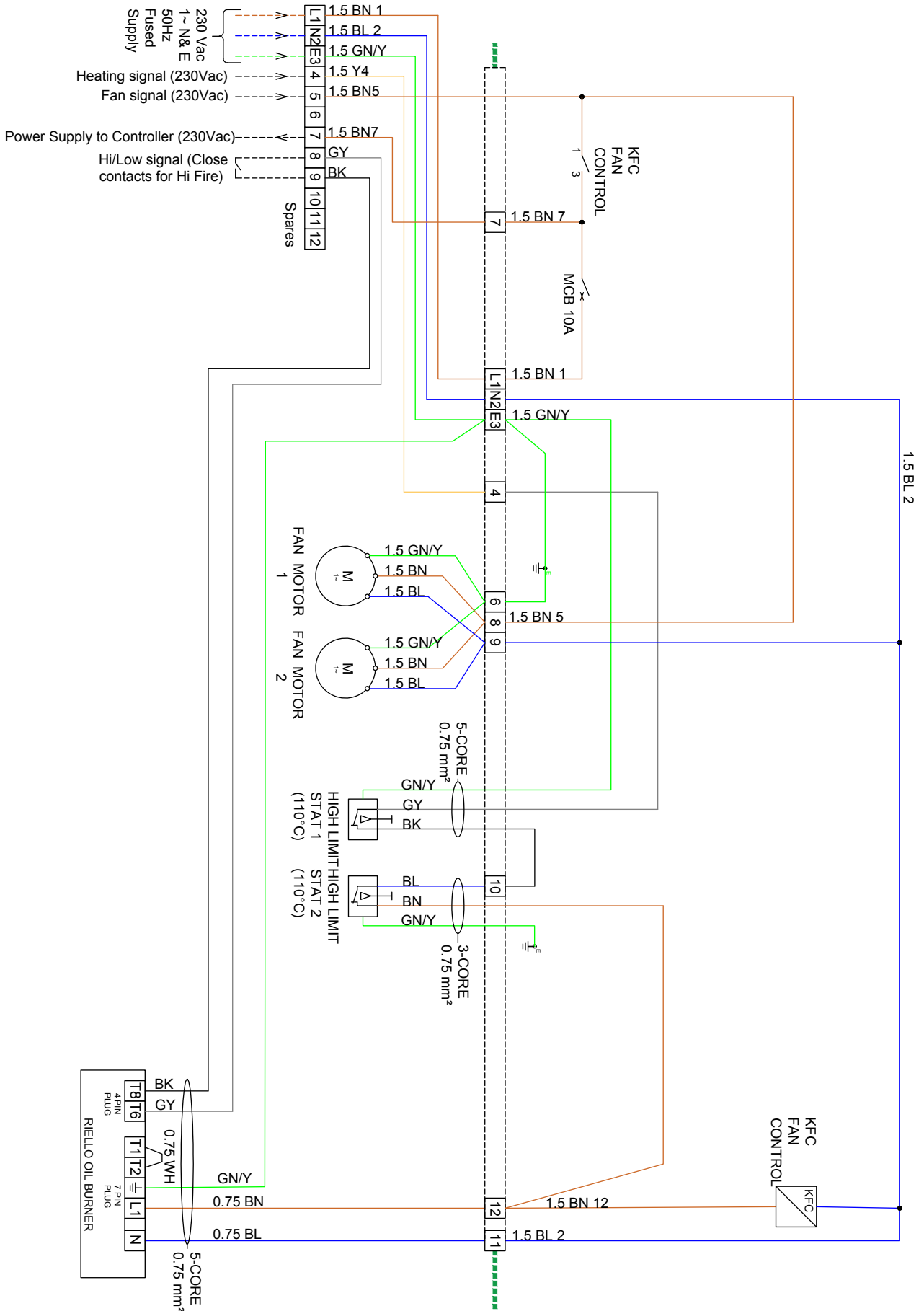

Wiring diagram 7365023  
 OUHAE 60-70  
 Hi Lo Riello Oil Burner  
 230/50/1ph

12 Way Terminal Block In Heater -  
 For Interconnections See Drawing:  
 7365025 for optional SMARTCOM MZ control panel wiring.  
 7365026 for optional NO control panel wiring

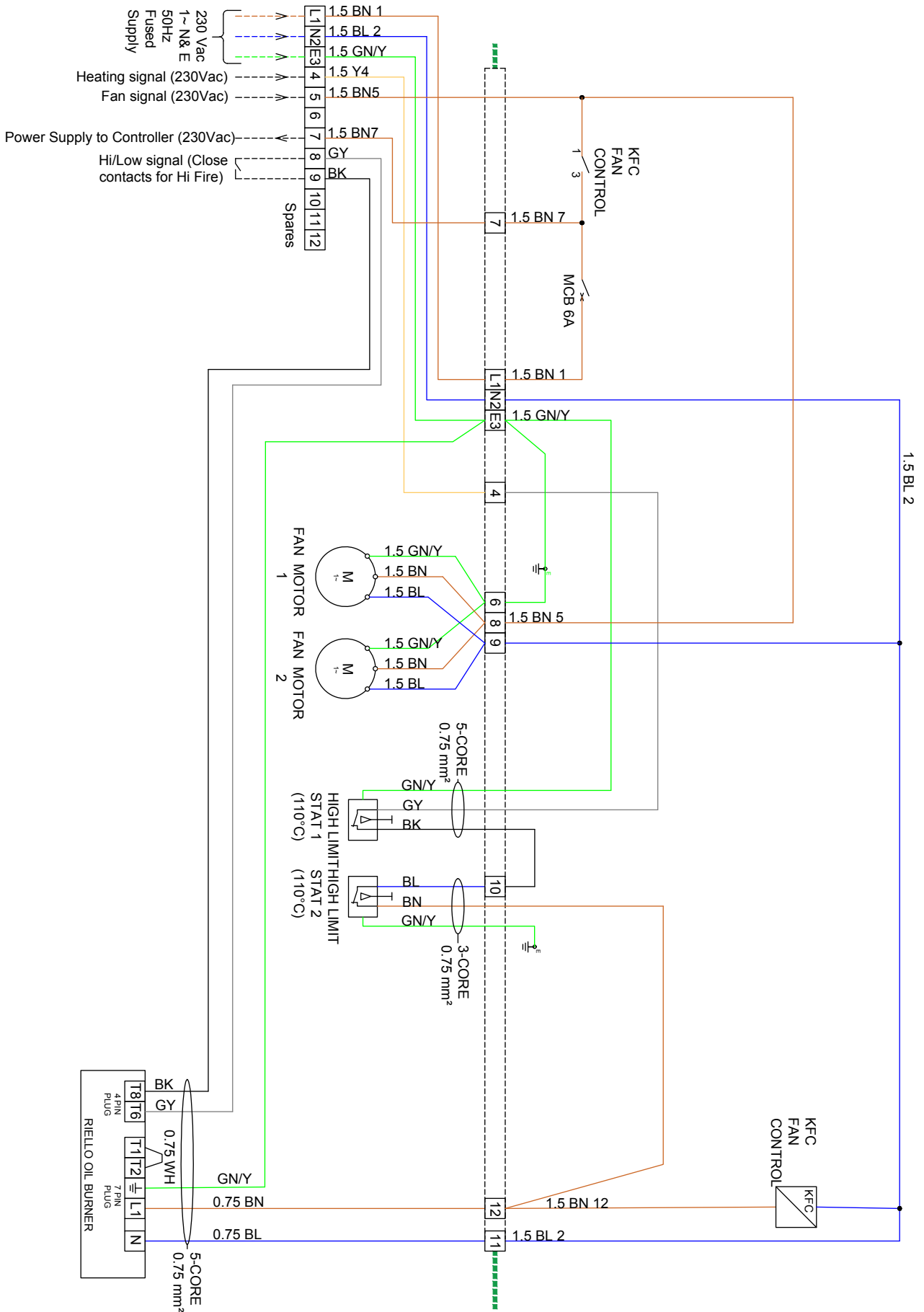

Wiring diagram 7365024  
 OUHEA/OUHEC 40  
 Hi Lo Riello Oil Burner  
 230/50/1ph

12 Way Terminal Block In Heater -  
 For Interconnections See Drawing:  
 7365025 for optional SMARTCOM MZ control panel wiring.  
 7365026 for optional NO control panel wiring

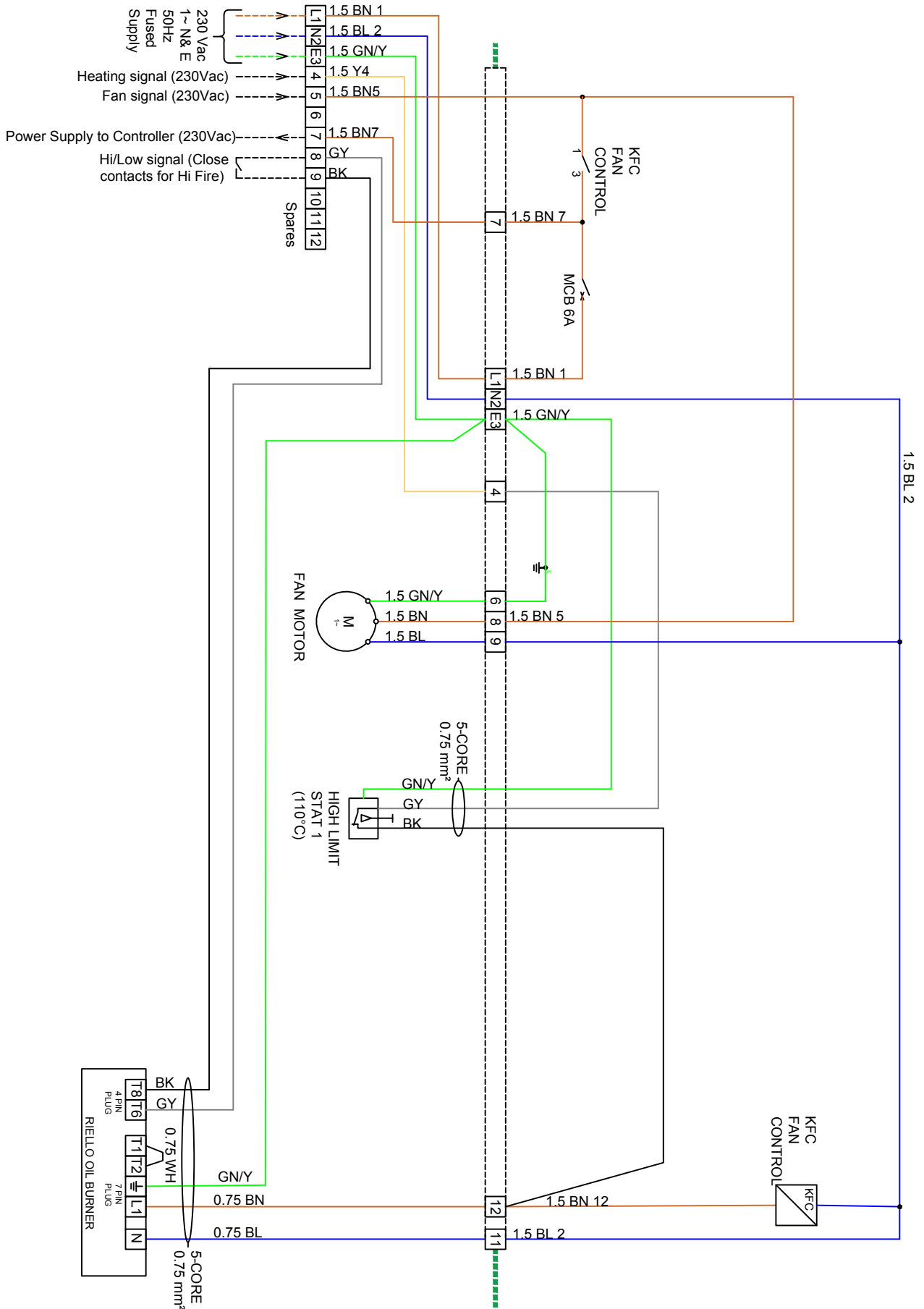

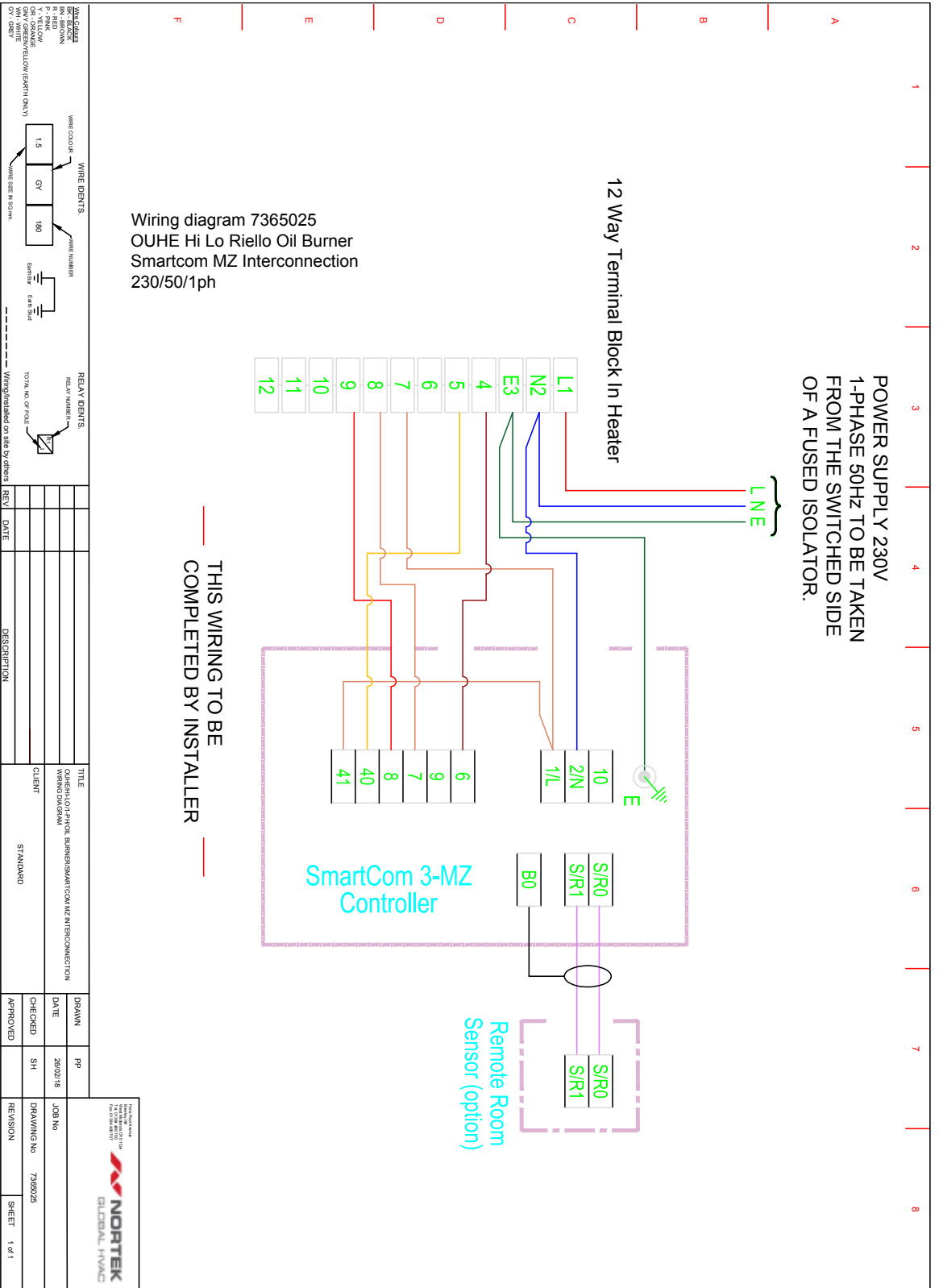

POWER SUPPLY 230V  
 1-PHASE 50HZ TO BE TAKEN  
 FROM THE SWITCHED SIDE  
 OF A FUSED ISOLATOR.

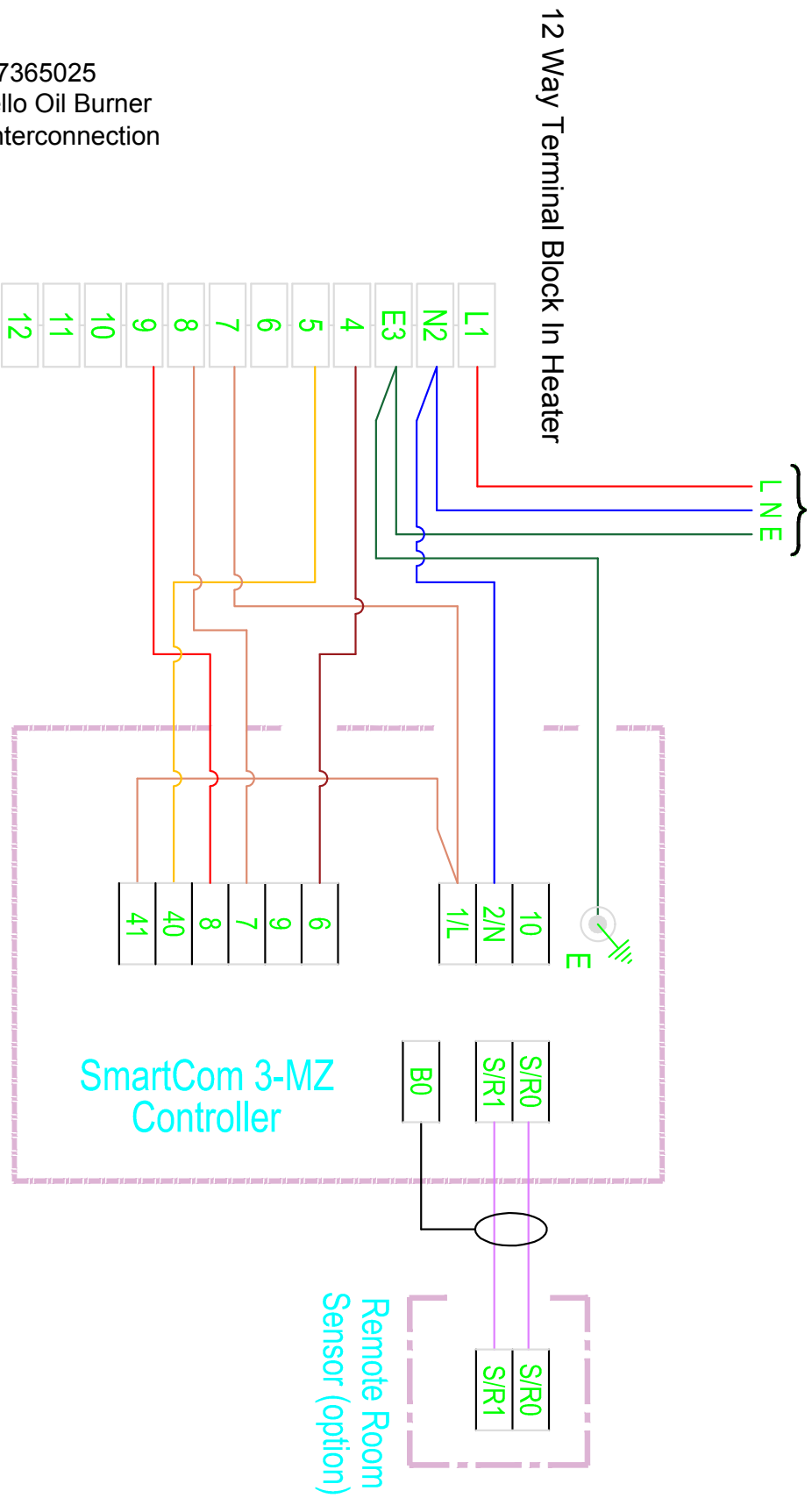

THIS WIRING TO BE  
 COMPLETED BY INSTALLER

Wiring diagram 7365025  
 OUHE Hi Lo Riello Oil Burner  
 Smartcom MZ Interconnection  
 230/50/1ph

## 3. Commissioning



It is a requirement that only suitably qualified and competent personnel are allowed to undertake the commissioning of the heater.



It is also strongly recommended that prior to commissioning the engineer familiarises himself with; the information contained within the information pack that accompanies the heater, the heater itself, and with the specific requirements of the installation /application.



All unit heaters undergo a rigorous test programme prior to being despatched, whilst such a programme does involve pre-commissioning and setting up the heater to operate efficiently and well within its designed operational limits, this does not mean that on site commissioning is less important than might otherwise be the case.

The idiosyncrasies of each installation can only ever be allowed for, through the use of thorough on site commissioning carried out by trained and experienced personnel equipped with the correct tools and apparatus.



It is strongly recommended that equipment used for the sampling and analysis of flue gases is accurate to within +/- 0.1% and maintained so that it is regularly calibrated.

### 3.1 Commissioning - Pretest

Check to ensure electrical safety, and inspect and check the oil installation, testing for leaks.

- (a) Ensure that the electrical supply is turned off.
- (b) Ensure that the oil supply is turned off.
- (c) Check that all panels and fasteners are secure and in place.
- (d) Check that the heater is installed so that it is square and that the support is adequate.
- (e) Ensure that warm air delivery outlets are open and that ducting is adequately supported.
- (f) Check that fan is free to rotate and the guards are in place.
- (g) Ensure that the flue is secure, adequately supported, and that the various joints are properly sealed.
- (h) Check that there is provision for flue gas sampling and that this sample point can be plugged and sealed after commissioning.
- (i) Ensure that the burner is securely attached to the heater.
- (j) Test for electrical earth continuity between the heater, oil pipe work, and mains supply.
- (k) Turn on main electrical supply.
- (l) Enable fan on via controller by selecting 'Fan only'; 'Vent only'; 'Vent/Manual'.\* (\* dependent on control type supplied. Refer to individual controller operating manual.)
- (m) Check to ensure burner is off but power remains to the fan. The fan will start enabling fan direction etc to be verified. Reset Fan on/standby switch to off.
- (n) Set room thermostat and time clock to 'demand' positions.
- (o) Turn mains electrical supply to off, replace and secure lower louvered panel covering fan and motor assembly.

## 3.2 Commissioning - Ignition



It is strongly recommended that the separate manual concerning the operational details of the burner supplied with the heater as part of the information package is studied prior to commissioning.

Time intervals within the ignition sequence will vary slightly from one model to another.



Do not proceed with commissioning unless all the criteria detailed within sections 3.0 and 3.1 have been satisfied.

- (a) Ensure the electrical supply is turned off.
- (b) Ensure that the Oil supply is turned off.
- (c) Turn on main electrical supply.
- (d) Enable burner via controller by selecting 'Heat' (Relay 2); 'Heat On'; 'Heat/Auto'. \* (\* dependent on control type supplied. Refer to individual controller operating manual.)
- (e) Select 'on' position for heater on/standby switch.
- (f) Check for the following burner sequence on the right
- (g) Set heater on/standby switch to standby position
- (h) Attach oil manifold (bleed screw and pressure gauge)
- (i) Open oil supply valves and bleed air from pipe work and adjust burner oil pressure as per detailed in burner manual (section B)
- (j) Repeat steps 3.2 c, e, f



**If burner ignition is not satisfactorily accomplished, commissioning must not proceed until the reason or fault has been identified and rectified, if necessary by reference to the separate burner information or to section 6 of this manual.**

- (k) Repeat steps 3.2 c,a,
- (l) Repeat steps 3.2 d,e,f, allowing the heater to reach thermal equilibrium.
- (m) Adjust room thermostat to its highest setting, and allow the heater to continue to fire.
- (n) Gradually reduce the temperature setting on the room thermostat until the burner shuts down, (@ < ambient and then gradually increase the temperature setting on the thermostat until heat is called for, (@ > ambient) and the burner automatically re-fires.
- (o) Re-set time clock to a minimum off period, checking that the burner shuts down, and then automatically re-lights once the minimum off period has elapsed (Separate information on the time clock is contained within the information package supplied with the heater).
- (p) Check limit stat by tripping the fan motor overload re-set by pressing the reset button on the overload, located on the heater electrical panel. The time between the fan stopping and burner shut down should be noted (90 seconds max), once the burner has shut down the overload on the motor should be released.
- (q) Undertake flue gas analysis using approved and calibrated analysing equipment recording data on the commissioning card, ie, CO, CO<sub>2</sub>, net and gross flue temperatures.

Record burner oil pump pressure, ambient temperature, barometric pressure, and smoke reading (0 - 1 Baccarach scale).

### Note (i)

The burner air and oil pressure settings should be only very finely adjusted to achieve a CO<sub>2</sub> reading of 12.5% (+/- 0.5%).

### Note (ii)

The gross efficiency must be approximately 80% sample taken at 1m above the flue spigot point.

#### Burner Sequence

Interval	Operation
1 <5s	Combustion air damper actuated, burner fan motor initiates purge cycle.

2 <40s	Solenoid valve opens ignition transformer provides spark for burner ignition
--------	--

#### EITHER

Interval	Operation
3 >15s	Ignition failure caused by oil starvation resulting in burner lock-out/shutdown

#### OR

Interval	Operation
3 >15s	Burner ignition
4 <20s	Burner ignition cycle complete



### Note (iii)

All unit Heaters are test fired and pre-commissioned as part of the manufacturing process, if however, during on site commissioning the data are found to be not in accordance with the manufacturers data, then the following action is recommended.

\* Re-check all readings and calculations.

\* Adjust burner as per manufacturers instructions.

\* Consult the Technical Department, details on rear page.

(r) Complete commissioning card and provide operating instructions for the user, high-light the fact that the manufacturer recommends that in the interests of safety and efficiency the heater is serviced on a regular basis only by qualified and competent persons.

The completed commissioning card must be returned to the supplier (details on rear page) immediately after the satisfactory completion of commissioning, failure to do so can invalidate any subsequent warranty claim.

(s) Set all controls to the requirements of the user.

(t) Final adjustment for the direction of the air flow from the heater should be made.

### 3.3 Commissioning - air delivery system

Final adjustment of the air louvres are adjusted outwards and ensure blades are not resonating.



On ducted applications it is necessary that the system is balanced in order to optimise the efficiency of the heater and the air distribution and delivery system. Failure to balance the system can result in fan motor overloading and premature component failure, it can also result in an inefficient heating/ventilation system.

(a) Check that the amount of fan produced air volume is in accordance with the heater specification, if the volume is too great the fan can be overloaded. Ensure that the running current is as per that stated on the heater data plate.

Alternatively, the static pressure should be measured at the start of the ductwork to confirm that it is within the permissible tolerance.

(b) If the current drawn is greater than the stated running current, in most probability this will be caused by insufficient static pressure within the ductwork, in which case system resistance should be increased through the introduction of a damper placed as close to the start of the ductwork as possible, thereby resulting in a reduction in drawn current.

The damper should be adjusted until the current is in accordance with that stated on the data plate.

(c) If the current drawn is too low the duct outlet grilles will require opening to reduce static pressure and increase air volume, if this is not the case overheat cut outs can be caused.

### 3.4 Commissioning - hand over

(a) Upon full and satisfactory completion of commissioning, a record of commissioning information (contact, date, etc) should be left with the heater, a copy of which must also be forwarded to the supplier (details on rear page)

(b) The commissioning engineer must ensure that the user is familiar with the safe and efficient use of the heater, detailing the function of all controls, and main components.

(c) The user should be made aware of the following in particular

- (i) Lighting, shut-down, and operational information.
- (ii) Safety features, data plate, and labelling.
- (iii) The requirement for regular inspection - especially if the heater is within a more demanding environment - and the need for regular servicing carried out by competent and qualified persons.

(d) Section 8 'User Instructions' should be left with the customer upon satisfactory completion of the commissioning and hand-over.

## 4. Servicing

Servicing must be carried out on a regular basis, the maximum interval between services being 1 year.

 In certain applications the frequency of servicing will have to be increased, this to a large extent is governed by the working environment.

 It is a requirement that only suitably qualified and competent persons are allowed to undertake servicing. Before any maintenance or servicing work is carried out the heater must be shut down and allowed to cool, and have the oil and electric supplies to it turned off at the supply valve and isolator respectively.

 Certain component parts are factory sealed and are designed so as to be tamper proof. Usually such items do not require servicing, and therefore should not be tampered with.

 Failure to comply with this can invalidate any warranty, and can also lead to premature failure.

The following parts fall within this category: room thermostat, time clock, frost thermostat, sequential controller, and fan and motor.

Reference should be made to the separate information covering the operational details of the burner and timer.

Only approved spare/replacement parts can be fitted, failure to comply with this can compromise the safe and efficient running of the heater, and can also invalidate any warranty claim.

### 4.1 Planned Servicing

In order to maintain the efficient operation of the heater it is recommended that the following planned servicing and preventative maintenance programme is adopted by the user.

#### Quarterly Inspection

- (a) Visual inspection of the burner
- (b) Clean and check spark electrode
- (c) Clean and check photocell
- (d) Check overheat safety is operational

#### Bi-Annual Inspection

- (a) As per quarterly inspection, plus...
- (b) Combustion check
- (c) Smoke test

#### Annual Inspection

- (a) As per half year inspection, plus...
- (b) Heat exchanger and cleaning
- (c) Electrical connections
- (d) Main fan motor
- (e) Oil supply including filter
- (f) Burner
- (g) Air delivery system
- (k) Flue

### 4.2 Servicing Procedure - Major Component Parts

#### 4.2.1 Flue

A visual inspection should be carried out to ensure that the flue remains adequately supported, both internally as well as externally, and that the various joints are effectively sealed.

Inspection covers, where fitted, should be removed and the flue checked to see whether cleaning is required. If inspection covers are not fitted the flue gas exit duct and flue spigot will provide not only an indication of the cleanliness of the flue, but will also enable access for cleaning. The presence of the flue terminal should be checked. If a condensate trap and drain facility is fitted this should be checked to ensure that it continues to function correctly, and the drainage of condensates is not impaired.

### 4.2.2 Main Fan

Remove dust and other foreign matter by blowing off with compressed air or through the use of a soft bristle brush.

Check that the bearings do not show signs of excessive wear. It should be noted that these bearings do not require lubricating.

### 4.2.3 Heat Exchanger

The heat exchanger requires a visual inspection at least once per year, this should be accompanied by cleaning.

It is recommended that a flue brush and vacuum cleaner be used to facilitate this.

Access to the heat exchanger is gained through the removal of the rear fan, front louvres and opening the access door.

Servicing and cleaning should be performed as follows:

- (a) Remove brass nuts and cover from heat exchanger end assembly to expose heat exchanger tubes.
- (b) Remove any accumulated deposits from the tubes by pushing through the full length with a flue brush.
- (c) The flue brush should be withdrawn so as to pull any deposits back into the bottom of the flue box where they can then be removed by using a vacuum cleaner.
- (d) Particular attention should be paid to the upper internal surfaces of the tubes, where through convection heavier deposition is likely to occur.
- (e) Any deposits which may have accumulated within the combustion chamber can be removed with a vacuum cleaner once the burner is removed.



It is most important that a build up of deposits is not allowed to occur as this can have an adverse effect upon the efficiency of the heater and reduce the life of the heat exchanger.

- (f) The heat exchanger and combustion chamber should be visually inspected for signs of splits, cracks, and distortion.
- (g) All gaskets should be checked to ensure that they continue to provide a gas tight seal, if there is an element of doubt then they should be replaced.

If the condition of the heat exchanger gives cause for concern the suppliers Service Department should be advised pending a more detailed examination. Details on rear page

### 4.2.4 Electrical Supply

All connections must be checked to ensure that they are secure, and free from corrosion.

Terminals and connections should also be checked to ensure that no stray strands are bridging terminals.

Electrical continuity should also be checked.

### 4.2.5 Oil Supply

The oil supply pipe work, tank, and fittings should all be inspected to ensure that they are free from corrosion, and to ensure that where brackets have been fitted these remain secure and offer adequate support.

The oil filter should be replaced with a new one, and the system should be checked for leaks. If the oil level is such to allow removal of any sludge or other contaminants from the tank this too should be undertaken, particularly if there have been problems of poor firing associated with contaminants reaching the burner.



Any waste oil or sludge must be disposed of correctly. Never dispose of it by dumping or tipping it down drains or into watercourses where ground water can become polluted and environmental damage caused.

#### 4.2.6 Burner

Service requirements for the burner fitted to the unit heater are covered in the separate manual prepared by the burner manufacturer.

 It is most important that the burner is serviced regularly and in accordance with the manufacturers instructions.

#### 4.2.7 Air Delivery System

A visual inspection should be undertaken to ensure that the air delivery system is in good order, that it remains adequately supported and that the various joints are effectively sealed.

#### 4.2.8 Report

A full and detailed service report should be prepared, it is advised that the report is not completed until the heater has been re-commissioned, where upon the completed report can then be run through with the user.

### 4.3 Service Re-commissioning

The heater should be re-commissioned as follows, as per section 3.1 through to section 3.4 inclusive.

This must be regarded as a necessary part of the heater service. By the service engineer.



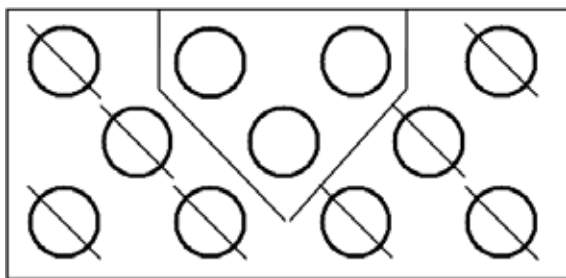



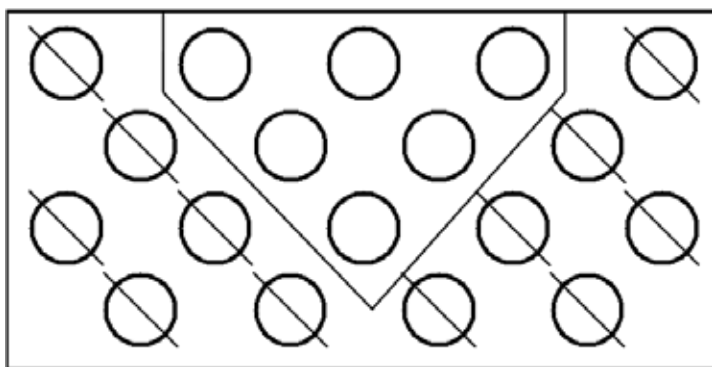





#### Turbulator positions in models 40 - 70. 8 off















#### Turbulator positions in models 90 - 100. 12 off



## 5 Parts Lists

Item	Heater Size /Description	40	60	70	90	100
	Burner 35s	29-99-602 RG1RKD	29-99-603 RG2D	29-99-603 RG2D	29-99-604 RG3D	29-99-604 RG3D
	Burner 28s	29-99-602 RG1RKD	29-99-603 RG2D	29-99-603 RG2D	29-99-604 RG3D	29-99-604 RG3D
	Burner Gasket	3005787	3005795	3005795	3005813	3005813
	Nozzle 35s	27-00-437	27-00-020	27-00-430	27-00-436	27-00-032
	Nozzle 28s	27-00-439	27-00-430	27-00-436	27-00-032	27-00-040
	Control Box	3001175	3001174	3001174	3001174	3001174
	Electrode Assy	3007513	3007495	3007495	3007495	3007495
	Photocell	3007839	3007839	3007839	3007839	3007839
	Fire Valve	29-03-007	29-03-007	29-03-007	29-03-007	29-03-007
	Oil Filter	29-15-017	29-15-017	29-15-017	29-15-017	29-15-017
	Rocker Switch Black	28-40-104	28-40-104	28-40-104	28-40-104	28-40-104
	MCB 6A OUHA	28-07-084	28-07-084	28-07-084	n/a	n/a
	MCB 10A OUHA	n/a	n/a	n/a	28-07-085	28-07-085
	MCB 6A OUHC	n/a	28-07-084	28-07-084	28-07-084	28-07-084

Item	Heater Size / Description	40	60	70	90	100
	MCB 16A OUHC	n/a	28-07-086	28-07-086	28-07-086	28-07-086
	Contactor OUHC	n/a	28-11-137	28-11-137	29-11-137	28-11-137
	Limit Thermostat	73-65-005-S	73-65-005-S	73-65-005-S	73-65-005-S	73-65-005-S
	Fan Control Relay	28-16-059	28-16-059	28-16-059	28-16-059	28-16-059
	Fan/Limit Thermostat Gasket	20-45-589	20-45-589	20-45-589	20-45-589	20-45-589
	Secondary Limit Thermostat	n/a	28-16-058	28-16-058	28-16-058	28-16-058
	Sight Glass	20-30-151	20-30-151	20-30-151	20-30-151	20-30-151
	Heat Exchanger Assembly	33-65-003	33-65-062	33-65-062	33-65-079	33-65-079
	Turbulators	20-46-639	31-27-189	31-27-189	31-27-189	31-27-189
	Burner Spigot Gasket	31-28-080	31-40-156	31-40-156	31-40-156	31-40-156
	Axial Fan OUHA	29-09-008	28-09-008	28-09-008	28-09-007	28-09-007
	Motorised Fan OUHC	n/a	28-09-001	28-09-001	28-09-152	28-09-152

## 6. Fault Finding Guide

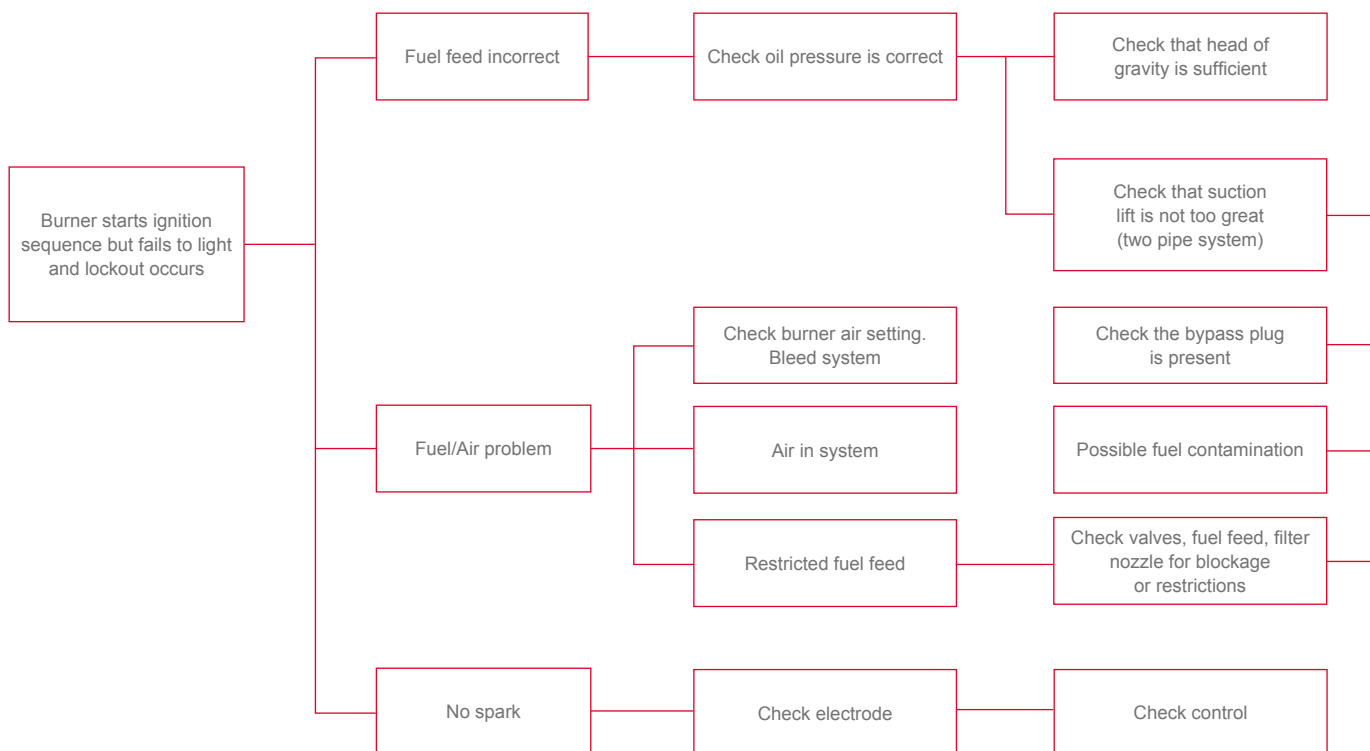
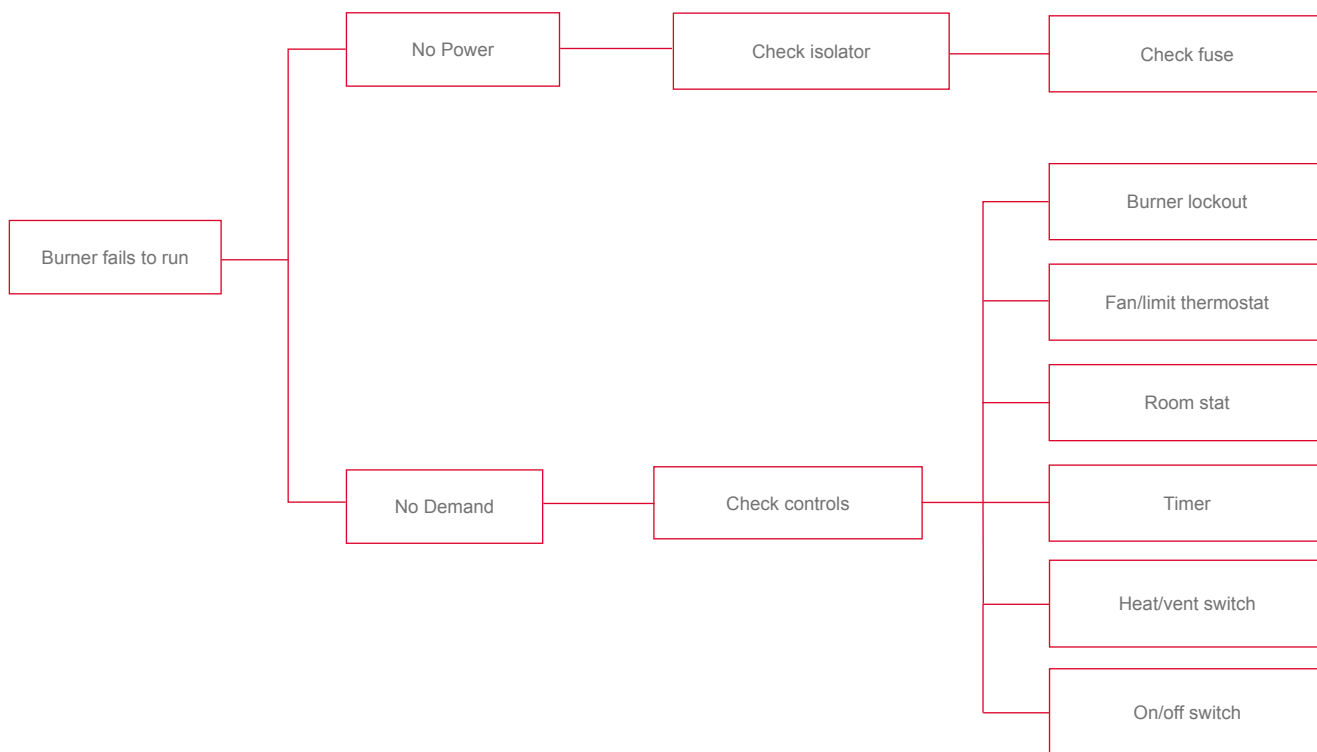

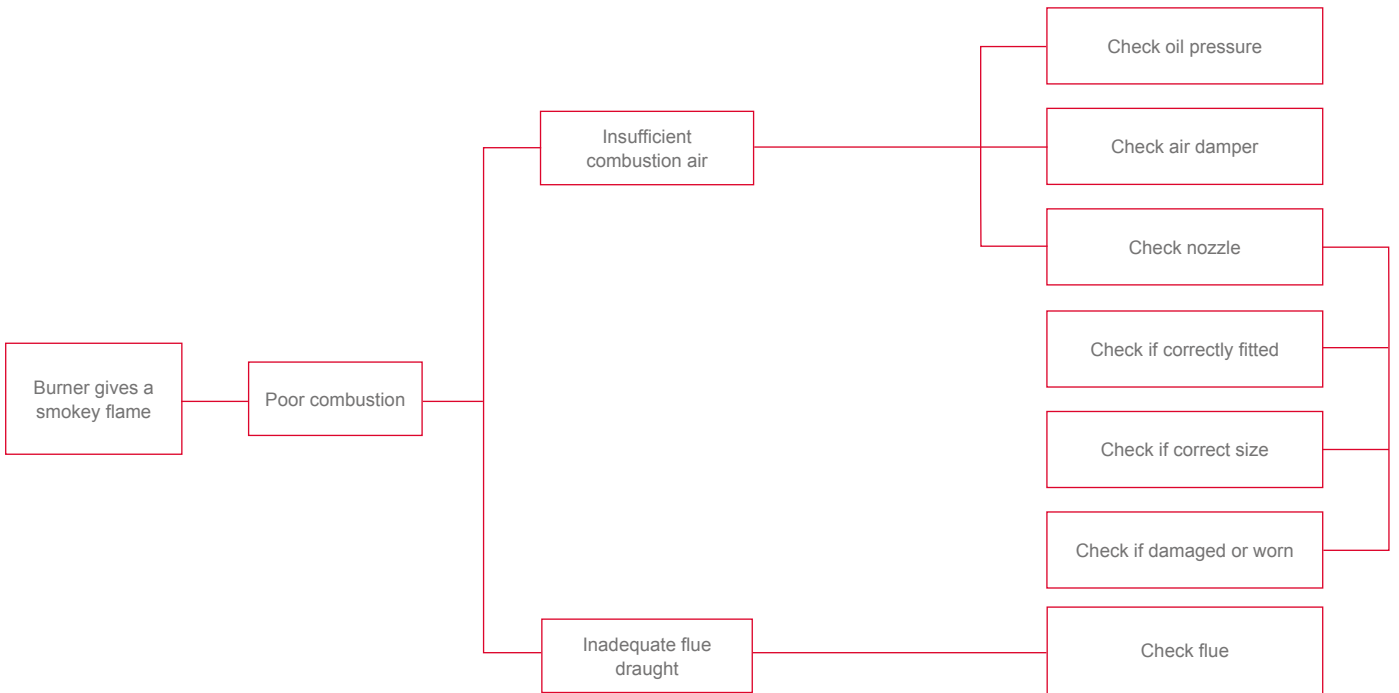
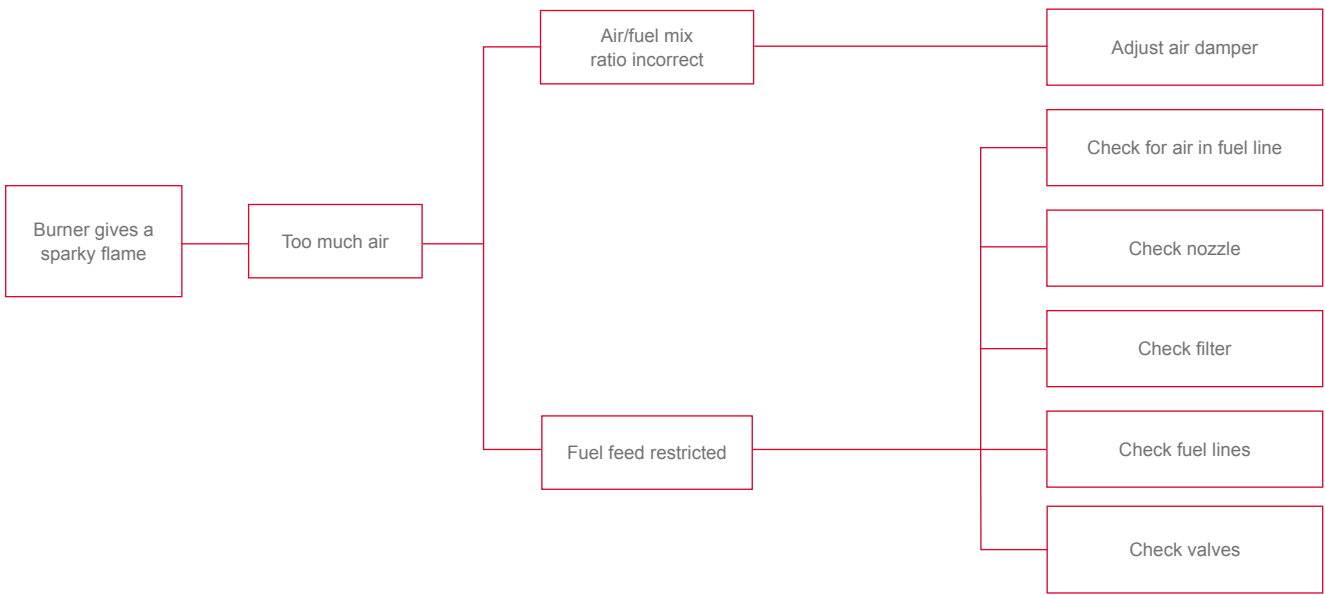



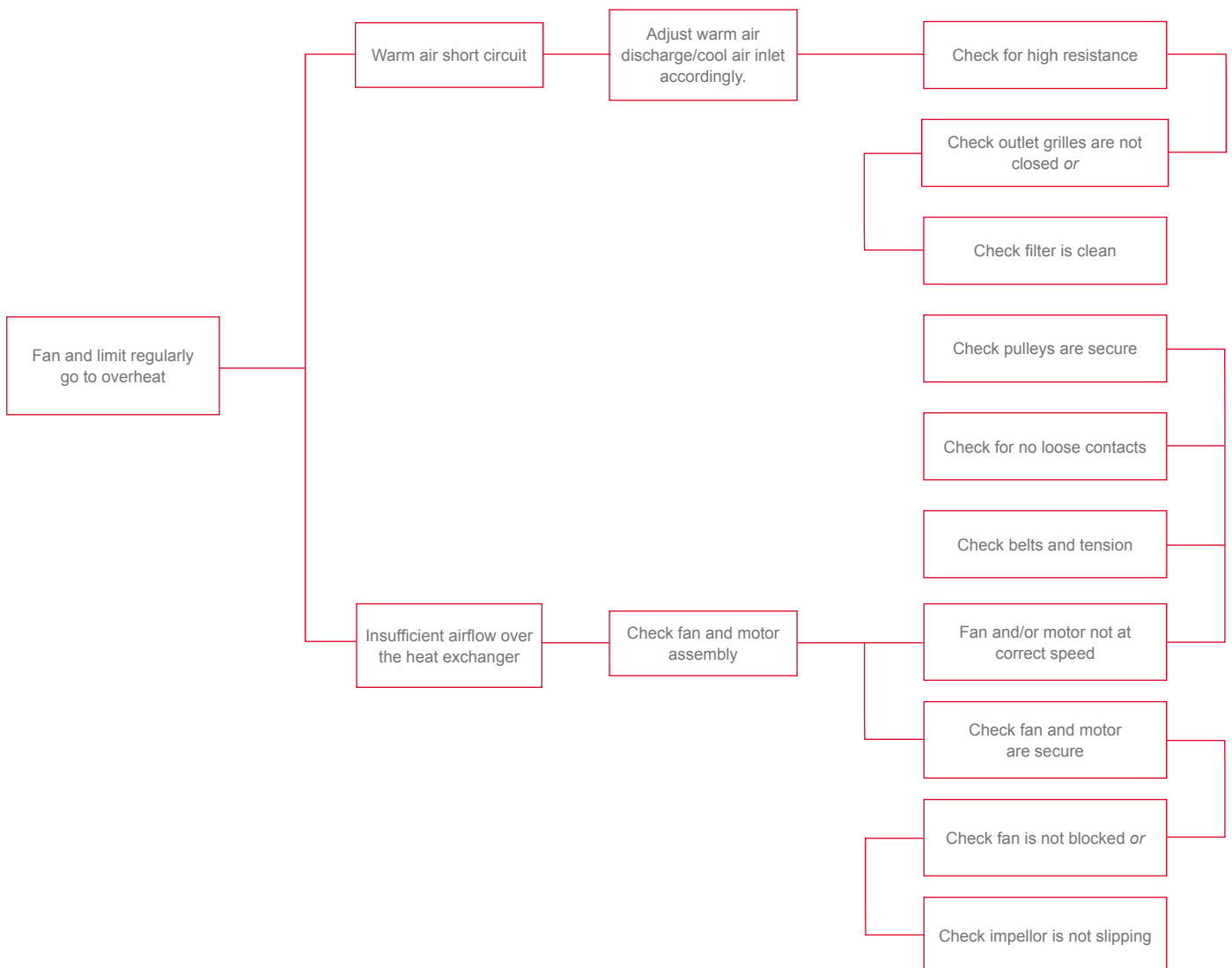
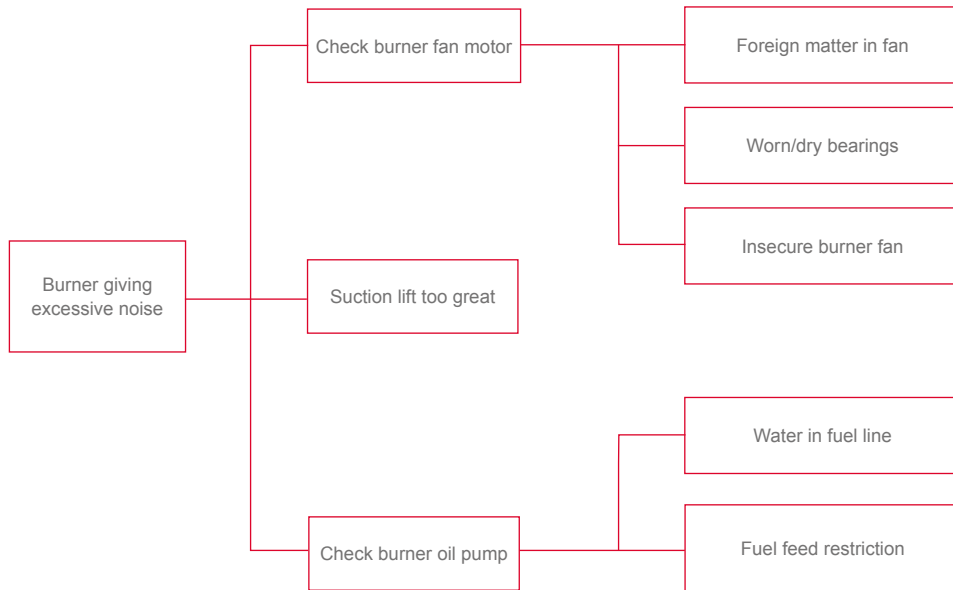

## 7. Replacement Parts



It is recommended that only suitably competent persons are allowed to undertake replacement of parts.



### 7.1 Burner

- Disconnect electrical supply to the heater and shut off oil supply.
- Disconnect fuel line.
- Open the controls compartment door.
- Remove the oil fired burner cover.
- Detach electrical connections via plugs.
- Using an 13mm spanner, remove the nut holding the unit to the burner flange.
- Withdraw the burner from the throat of the heat exchanger.
- Replace in reverse order.



### 7.2 Controller

- Disconnect electrical supply to the heater.
- Open the controls compartment door.
- Remove the oil fired burner cover.
- Remove the screw fixing the controller to the base and withdraw controller.
- Replace in reverse order.



### 7.3 Electrode Assembly

- Disconnect electrical supply to the heater.
- Open the controls compartment door.
- Remove the oil fired burner cover.
- Using an 13mm spanner, remove the nut holding the unit to the burner flange.
- Withdraw the burner from the throat of the heat exchanger, support on bracket/flange lugs.
- Remove the fixing screw(s) holding the End Cone and withdraw from burner head.
- Loosen the screw clamping the electrodes.
- Replace in reverse order.

## 7.4 Nozzle



- Disconnect electrical supply.
- Open the controls compartment door.
- Remove the oil fired burner cover.
- Using an 13mm spanner, remove the nut holding the unit to the burner flange.
- Withdraw the burner from the throat of the heat exchanger.
- Remove the fixing screw(s) holding the End Cone and withdraw from burner head.
- Using a 17mm spanner, remove the nozzle
- Replace in reverse order.

---

## 7.5 Photocell



- Disconnect electrical supply.
- Open the controls compartment door.
- Remove the oil fired burner cover.
- Remove the screw fixing the controller to the base and withdraw controller.
- Withdraw photocell from front of controller.

---

## 7.6 Oil Pump



- Disconnect electrical supply to the heater and shut off oil supply.
- Disconnect fuel line.
- Disconnect single pipe (or 2 pipe) oil lines from the pump.
- Open the controls compartment door.
- Remove the oil fired burner cover.
- Remove the nut securing the coil and withdraw coil.
- Remove the 3 screws fixing the pump onto the motor shaft.
- Withdraw pump carefully
- Replace in reverse order.

## 7.7 Contactor



- Disconnect electrical supply to the heater.
- Open the controls compartment door.
- The contactor and overload are located on the electrical panel plate situated on the right hand side of the unit.
- Disconnect all wiring to the to the contactor noting which cables are connected to which terminals
- The Contactor is attached to a DIN rail using a spring loaded din fixing clip - using a small flat head screwdriver, prise the clip downwards to release the MCB.
- Replace in reverse order.

---

## 7.8 MCB



- Disconnect electrical supply to the heater.
- Open the controls compartment door.
- The MCB is located on the electrical panel plate situated on the right hand side of the unit.
- Disconnect the two cables from the MCB noting which cables are connected to which terminals
- The MCB is attached to a DIN rail using a spring loaded din fixing clip - using a small flat head screwdriver, prise the clip downwards to release the MCB.
- Replace in reverse order.

---

## 7.9 Fan/Limit Stat Assembly



- Disconnect electrical supply to the heater.
- Loosen the cable gland then disconnect the three cables from the fan stat (left hand) and the two cables from the limit stat (right hand) noting which cables are connected to which terminals.
- Remove the two screws fixing the assembly to the body of the heater.
- Carefully withdraw the assembly through the hole and replace in reverse order.



## 7.10 Axial Fan

The axial fan is removed from the rear of the heater (opposing side to the outlet). Ensure there is enough room to work in and to withdraw the fan blower.

- Disconnect electrical supply.
  - Open the controls compartment door.
  - Disconnect fan connection to the electrical terminals within the controls compartment
  - Remove the four bolts fixing the fan guard to the rear panel
  - Carefully withdraw the fan by sliding it out from the rear.
  - Replace in reverse order
-

# Notes

# 8 User Instructions

## 8.1 Commissioning and hand over



As part of the commissioning programme, the commissioning engineer must go through the following with the operator.

- (i) Lighting, shutdown, and operational information.
- (ii) Safety features, data plate, and labelling.
- (iii) The requirement for regular inspection - especially if the heater is within a more demanding environment - and the need for regular servicing, carried out by competent and qualified engineers.



After approximately 100 hours of running, the fan must be checked to ensure that it is correctly working. It is strongly advised that this is undertaken by the commissioning engineer, and not the operator

## 8.2 Servicing



Servicing must be carried out on a regular basis, the maximum interval between services being one year.

It is a requirement that only suitably qualified and competent persons are allowed to undertake the servicing.

The manufacturers advise that the planned service schedule as detailed in section 4.1 of the Installation, Commissioning and Servicing Manual is adopted by the user.

Further details are available from either the commissioning engineer or from the Manufacturer (details below).

## 8.3 Start Up Procedure

- (a) Enable burner via controller by selecting 'Heat' (Relay 2); 'Heat On'; 'Heat/Auto'.\*  
(\* dependent on control type supplied. Refer to individual controller operating manual.)
- (b) Burner will fire and establish within 60seconds.
- (c) As temperature of heater increases, fan will operate.

## 8.4 Stop procedure

- (a) Disable burner by selecting 'Heat OFF'; 'Standby'.\* (\* dependent on control type supplied. Refer to individual controller operating manual.)
- (b) The burner will turn off.
- (c) The fan motor will continue to run until heat dissipation allows the fan and limit stat to shut down the fan.



Do not use the main electrical isolator to turn off the heater, to do so can cause damage to the heat exchanger and combustion chamber and thereby invalidate the warranty.

## 8.5 Shut down procedure

- (a) Follow steps 8.4 (a), (b) and (c), when main fan stops turn main electrical isolator off, and shut off oil supply.

## 8.6 Ventilation only

- (a) Enable fan on via controller by selecting 'Fan only'; 'Vent only'; 'Vent/Manual'.\* (\*dependent on control type supplied. Refer to individual controller operating manual.)
- (b) Fan will operate without the burner for the set period of the controller.

## 8.7 Lockout situations

If either the burner or the fan and limit stat go to lockout, the lockout must be cleared manually before the ignition sequence can be re-initiated.



Repeated or frequent lockouts must be investigated and their cause determined by a qualified and competent engineer.

This manual replaces the previous manual: Part No. Reznor, OUH, EN, Nov, 18, D301030 Issue E  
Current full Part No. Reznor, OUH, EN, Jan, 19, D301030 Issue F



**Nortek Global HVAC (UK) LTD**

Fens Pool Avenue, Brierley Hill  
West Midlands, DY5 1QA  
United Kingdom

**Tel:** +44 (0) 1384 489 250

**Fax:** +44 (0) 1384 489 707

**Email:** reznorsales@nortek.com

